

NEMESIS 5100G2

AUTOMATIC HARDNESS TESTER

UNIVERSAL | ROCKWELL, VICKERS, KNOOP & BRINELL



NEMESIS 5100G2

Cutting edge technology, and beyond...

The second generation of the NEMESIS 5100, the G2, Rockwell / Vickers / Knoop and Brinell hardness tester provides exceptional performance, designed to match the most demanding user tasks. The NEMESIS 5100G2 contains a revolutionary force application range and renewed optical system.

The all new 9 position tool changer (turret) accommodates a wide range of indenters, indenter actuators with load cells, objectives, a cross-laser positioning system and a load cell supported touch probe. It also provides a base to the 18 megapixel full color measurement camera and 18 megapixel full color overview camera with variable field of view, motorized zoom and auto focus system.



HARDNESS SCALES



VICKERS
+ HVD (HVT) 10gf - 150kgf



KNOOP 10gf - 5kgf



BRINELL
+ HBD (HBT) with AI 1kgf - 3000kgf



ROCKWELL 3kgf - 150kgf



Select your required test force range...

10gf	200gf	NEMESIS 5100G2 / A	250kgf	3000kgf
10gf	200gf	NEMESIS 5100G2 / B	750kgf	3000kgf
10gf	200gf	NEMESIS 5100 G2 / C		3000kgf

Upgrade now, later, at any moment, during order or online!

OPTION 1	10gf - 200gf	OPTION 2	250kgf - 750kgf
-----------------	--------------	-----------------	-----------------

HIGHLIGHTS

- 1 Multi load cell, closed loop system, custom test force configuration
- 2 Force range from 10gf up to 3000kgf
- 3 Force upgrade available also years after first installation
- 4 9 position tool changer (turret) with visual LED process indicators
- 5 Free to configure 8 objectives, 8 indenters, cross laser, touch probe, optional tools
- 6 Hardness tester & Metallurgy microscope with optional Metalloscope™ software
- 7 18 megapixel full color measurement camera, bright white LED TTL illumination
- 8 18 megapixel full color sample image & stage overview camera, anti-glare filter, motorized zoom for variable field of view and autofocus at any field of view
- 9 Adjustable & rotatable dual LED workspace illumination
- 10 iSMART™ docking station for CNC X-Y motorized or manual stage solutions
- 11 7 options for CNC X-Y high precision motorized iSMART™ stages (400kgf up to 4000kgf load)
- 12 Automatic workpiece height detection
- 13 Unique collision detection and test head retraction system
- 14 Integrated or External high performance, MS Windows based i7 system controller
- 15 IMPRESSIONS 4™ workflow and tester control system with 1 x 27" or 2 x 24" (touch)screens
- 16 Artificial Intelligence (AI) for enhanced Brinell readings
- 17 Top quality ABS replaceable body parts, no frame damage from falling objects

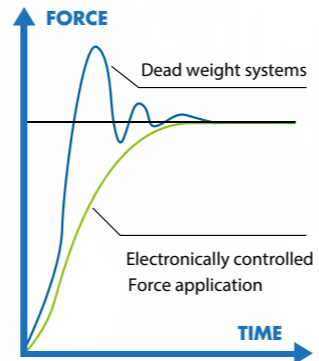

Load cell, closed loop, force feedback system

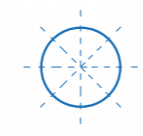

ROCKWELL

EN-ISO 6508, ASTM E-18, JIS Z 2245

Regular Rockwell scales; Pre Load 10kgf, Main Load 60kgf | 100kgf | 150kgf

A B C D E F G H K L M P R S V

Superficial Rockwell scales; Pre Load 3kgf, Main Load 15kgf | 30kgf | 45kgf

15N 30N 45N 15T 30T 45T 15W 30W 45W 15X 30X 45X 15Y 30Y 45Y

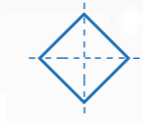

VICKERS

DIN EN ISO 6507, ASTM E-92, ASTM E-384

HV0.010	HV0.015	HV0.020	HV0.025	HV0.050
HV0.1	HV0.2	HV0.3	HV0.5	HV1
HV2	HV2.5	HV3	HV4	HV5
HV10	HV20	HV25	HV30	HV40
HV50	HV60	HV100	HV120	HV150



KNOOP

DIN EN ISO 4545, ASTM E-92, ASTM E-384

HK0.01	HK0.02	HK0.025	HK0.05	HK0.1
HK0.2	HK0.3	HK0.5	HK1	HK2
HK5				



BRINELL

DIN EN ISO 6506, ASTM E-10

HBW1/1	HBW1/1.25	HBW1/2.5	HBW1/5	HBW1/10
HBW1/30	HBW2.5/6.25	HBW2.5/7.8125	HBW2.5/15.625	HBW2.5/31.25
HBW2.5/62.5	HBW2.5/187.5	HBW5/25	HBW 5/31.25	HBW 5/62.5
HBW5/125	HBW5/250	HBW5/750	HBW10/100	HBW10/125
HBW10/250	HBW10/500	HBW10/1000	HBW10/1500	HBW10/3000



CONVERSIONS

DIN EN ISO 18265, DIN EN ISO 50150, ASTM E140

**SUPPORTED
METHODS & SCALES**

9-POSITION TOOL CHANGER

Full configuration freedom...

Newly developed 9 position state-of-the-art tool changer. From "turret" to tool changer because the 5100G2 turret offers more than purely holding lenses and indenters. The high-speed rotating mechanism is prepared for future modular plug & play tooling development. The tool changer is fully configurable.

Either 8 indenters or 8 objectives, or any combination, a laser positioning system and touch probe are installed as standard. The standard (removable) skirt protects tooling from damage.

LOW FORCE INDENTER POSITION

The low force indenter position is a complex assembly containing multi load cells providing a force range for Vickers, Knoop and Brinell from 10gf up to 187.5kgf. Multiple assemblies can be installed on the tool changer.

CROSS LASER & TOUCH PROBE

The cross laser & touch probe can be simultaneously used in the 9th position without loss of tooling positions. Multi touch probes available, with or without cross laser.

MEDIUM FORCE INDENTER SEATS

This indenter seat allows hardness testing ranging from option A: 200gf up to 45kgf for Vickers, Knoop, Brinell or option B: 1kgf up to 250kgf for Vickers, Knoop Brinell and Rockwell. Multiple indenter seats can be installed on the tool changer.

HIGH FORCE INDENTER SEAT

This indenter seat allows hardness testing ranging from 5kgf up to 3000kgf for Vickers, Knoop and Brinell. Multiple indenter seats can be installed on the tool changer.

COLLISION DETECTION SYSTEM

The collision detection system prevents tooling damage by early detecting obstructions in the test-path. The tool changer is continuously monitored during all movement processes and instantaneously stops and retracts if an obstruction is detected.



The LED bars on the front of the tool changer continuously inform you about the device status. The range of flash intervals and color codes (red, blue, green) indicate the process mode of the tester; **red**: automatic operation, (busy & hands off), **blue**: in single test procedure; or **green**: idle, ready for next task.

CRYSTAL CLEAR™ RINGLIGHTS

Brinell ringlights optimized for each magnification in combination with Artificial Intelligence (AI see page 23).

STAGE ILLUMINATION

Adjustable power LED banks provide excellent diffused stage illumination.

PROTECTION SKIRT

The skirt mounted on the rotating centre of the tool changer protects each individually installed tool against accidental damage.

DOCKING STATION

The NEMESIS 5100G2 has a iSMART™ docking station for the quick mounting of workpiece platforms. The docking station allows a wide variety of test tables, anvils, manual XY stages and the new wireless iSMART™ motorized CNC X-Y stages to dock within seconds. In this way, the user can create the most ideal circumstances for his particular workpiece.

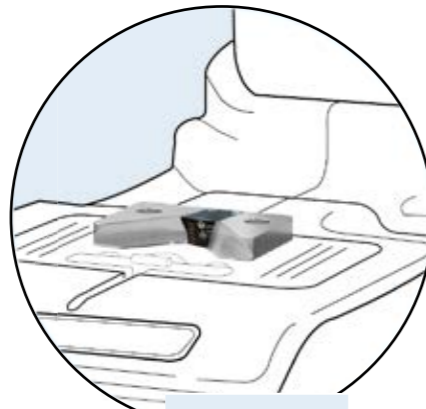

iSMART™
DOCKING STATION

The docking station is a new INNOVATEST standard. It can be found on an increasing number of hardness testers. This means that you can change your fixtures, stages, anvils and even the wireless iSMART™ motorized CNC X-Y stage between the various machines in your possession. No need to duplicate expensive tooling for different machines.

The iSMART™ docking station provides communication identification and power supply to various mounted accessories.

iSMART™ technology offers unlimited configuration freedom and safety for your tester. Creating a hardness testing system that can be configured to any requirements with standard or bespoke options, fitting a wide range of stage accessories and fixtures. Automatic Stage recognition provides overload protection and damage to accessories.

iSMART™ MANUAL | DIGITAL X-Y STAGES *A variety of manual and digital stages are available from the accessories list.*

Manual iSMART™ stage
UN-XYSTAGE/120
Surface: 100 x 100mm
Travel: 25 x 25mm



Digital control unit*
BM-08-0059
50 mm travel

Digital control unit*
BM-08-0058
25 mm travel



Manual iSMART™ stage
BM-08-0057
Surface: 150 x 150mm
Travel: 50 x 50mm

**Can be used on a variety of manual stages, see page 31 (Stage/anvils)*

Digital micrometer*
IMP-DIGMIC
25 mm travel



MOTORIZED CNC X-Y STAGES

The new wireless (or wired) iSMART™ motorized CNC X-Y stages provide excellent specifications combined with maximum flexibility. This new technology allows you to purchase a standard machine to start with, add stages, change dimensions of motorized CNC stages according to new requirements later in the life of the tester and upgrade in just seconds!

WIRELESS iSMART™ STAGES



iSMART™ technology reduces possible down time on stage maintenance to seconds in case of calamities. While most automatic machines will be "out of service" if the stage is defective, a wireless iSMART™ stage can just be exchanged in seconds. No downtime!

There is a choice of 7 different type of iSMART™ stages (see table below) and if you need larger dimensions or different specifications for Custom Products, we can manufacture any possible stage to your requirements.

iSMART™ stages have onboard controllers and the EIS (electronic identification system) communicates with your hardness tester to create safety and assure no stage overload can take place.

The stages have pre-determined hole patterns on their surfaces. These patterns are in line with all INNOVATEST hardness testing stage accessories such as 1, 4, 6 or 12 position sample holders, vices and others.

AVAILABLE DIMENSIONS

Type	MA-XY7575S	MA-XY1212S	MA-XY2212S	MA-XY3412S	MA-XY2015S	MA-XY3015S	MA-XY4015S
Travel mm	75x75	120x120	220x120	340x120	200x150	300x150	400x150
Surface mm	215x160	260x205	360x205	490x224	410x265	510x265	560x265
Max load kg	400	400	400	400	4000	4000	4000

Consult with our sales department for other dimensions with short lead times.

TECHNOLOGY HIGHLIGHTS

- High speed positioning by motors and drivers for medical applications.
- Ball bearing spindles with overload protection clutches.
- Integrated ultra precise position reading electronics.
- Position accuracy 0.001mm, repeatability 0.0015mm.
- 7 different dimensions and travel options, see table above.
- Maximum load 400kg or 4000kg.
- Quick Change iSMART™ adapter, mount stage in seconds
- Wireless or wired connectivity.
- Replaceable, upgradeable, interchangeable.
- Matt black finish for maximum contrast with objective and overview camera's.

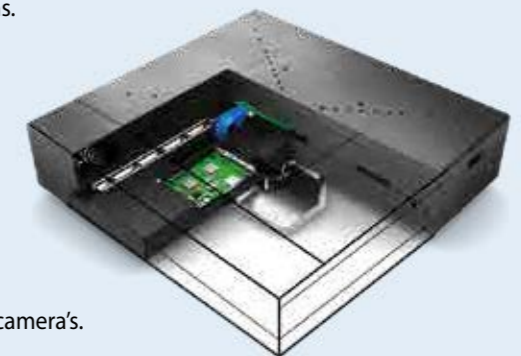

The purpose of software is to control complexity...

Software that optimizes user comfort with a wide range of standard functionality such as auto measurement, auto-focus, reporting, test program storage, and many more.

For the more advanced users, for whom the standard applications would not be sufficient, IMPRESSIONS™ 4 has an unmatched level of optional “apps” that can be installed as plugins, later, at any moment. During the purchase of your tester, decide on what you need at that moment. Widen your options at any moment by a simple e-mail and a few mouse clicks, to install optional functionality. As easy or simpler than installing an app on your mobile phone.

POWERED BY IMPRESSIONS v4

Next gen workflow & tester control...



Just buy a software release ticket, and your tester has added functionality, regardless where it is located. A revolutionary system taking care of all your needs.

In this way we keep the learning curve, the process to work efficiently with our software limited to the level of “need to have” and “need to know”. The proportion of installed and activated software never needs to be more than your requirements.

On the higher end, IMPRESSIONS 4 connects flawlessly with quality control systems such as QDAS, exports files in CVS, XML or other formats and if your requirement is not standard, our team of engineers will efficiently find ways to handle your data properly. Bespoke solutions such as connectivity to robotic systems are standard solutions for INNOVATEST™.

Unique to IMPRESSIONS™ 4 is a choice for screen size and position. Whether you wish your interface to be in portrait mode or landscape, all functionality is supported in both positions. For table top solutions like testers in laboratories, users often opt for landscape screen(s).

On the shopfloor the large landscape screens are often an unwanted component either requiring a table top or machine mounted bracket taking a lot of space and cables to deal with. IMPRESSIONS 4 leaves you the option to go for landscape or for portrait mode on a large selection of our machines.

For the NEMESIS 5100G2, INNOVATEST recommends the 27” industrial quality landscape screen operated by both touch as well as mouse and keyboard. One screen is standard included with the hardness tester, optional is the Dual view function, these are 2 x 24” industrial quality landscape screens. New applications are added to IMPRESSIONS™ on a regular basis; while INNOVATEST provides 10 years free updates, upgrades to more functionality or new additions can be purchased at any time.

TIME REDUCING SOFTWARE SOLUTIONS...

1 PATTERN EDITOR

The IMPRESSIONS™ pattern editor allows the user to create any number of test patterns with a large number of variable settings. Create test patterns with great precision and freedom. Verify the settings in the preview mode. Drag & drop patterns from one test sample to another sample. Live vision technique over zoom overview camera, no image stitching required.

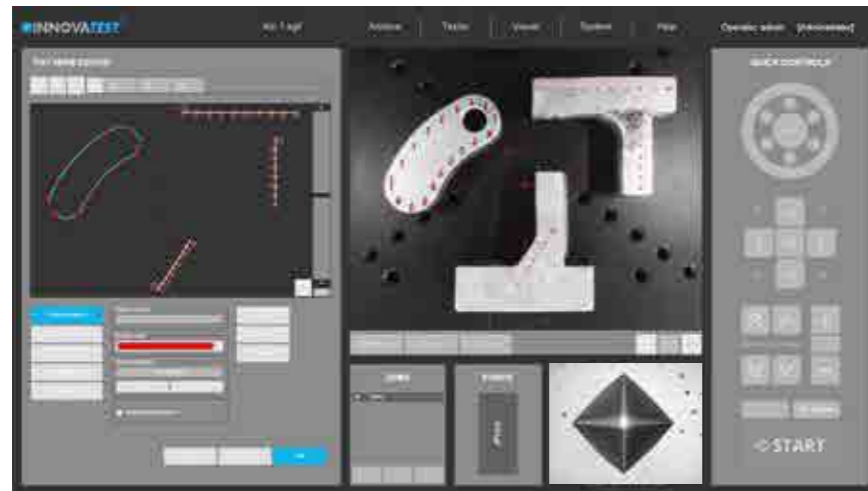

Combine different patterns and even different test forces in one program, and run them fully automatically. All test points can be identified individually or to customer specifications. The label is shown in the test result list and in the test results overview and in the results print out. An important function for sample analyses at the end of a test and in the future for review of previous tests.

2 CHD, SHD, NHD

How do you increase throughput in your lab? Make the most common testing design as easy to set up as possible to perform automatically and still adhere to the applicable standards. CHD/SHD/NHD testing can be started directly from the surface view or from the overview. Additional core points of hardness can be defined separately for NHD measurements.

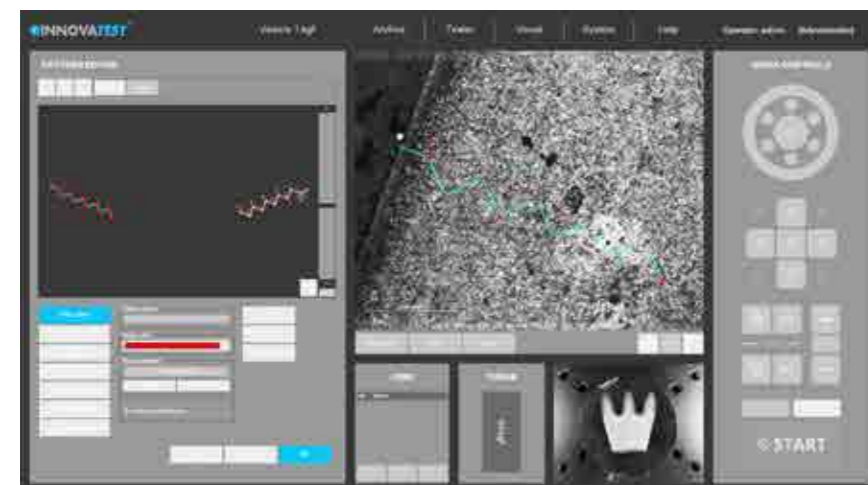

The distances of test points are automatically set to a minimum distance, following the standard, to assure correct testing is conducted. Time saving test mode "complete all indentations - then evaluate" and "auto-stop" to complete test series as soon as the lower hardness limit has been reached. Report Generator is enhanced with reporting features for this application.

3 WELD INSPECTION (ISO 9015)

This especially developed tool enables you to conduct hardness testing on welded parts or segments according to ISO standard. Setting up the pattern according to the requirements becomes "easy-to-do", due to pre-set test points in the different zones of the weld and automatic correlation between test points. The system will run a fully automatic test procedure and display and record the results accordingly. The Report Generator is enhanced with reporting features for this application.

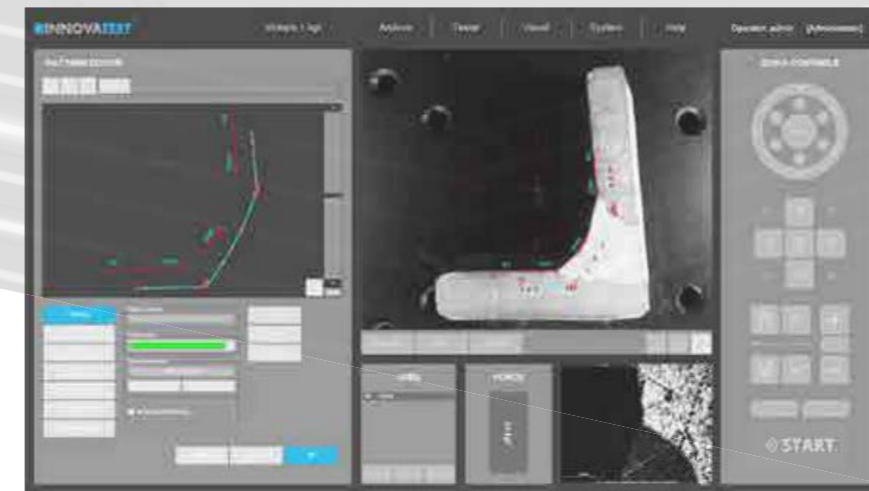

4 HARDNESS OF SCREW THREAD DECARBONIZED ZONE (ISO898-1)

A specialized software tool of IMPRESSIONS™ allows you to set up and conduct fully automatic testing as per ISO898-1 for screw thread measurement of (de)-carbonized part.

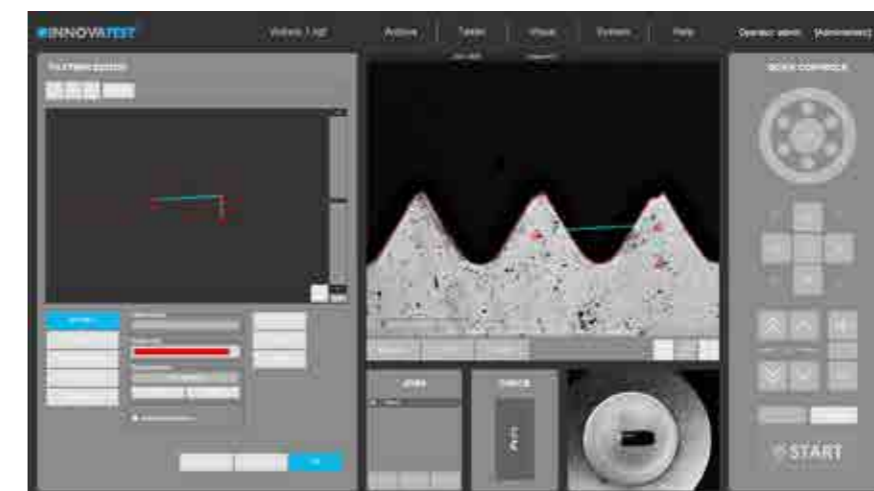

The Report Generator is enhanced with reporting features for this application.

5 EDGE DETECTION

Technology that automatically or at a mouse click recognizes the edge of your sample. This helps to determine and fix the desired starting position for CHD or other pattern testing jobs.

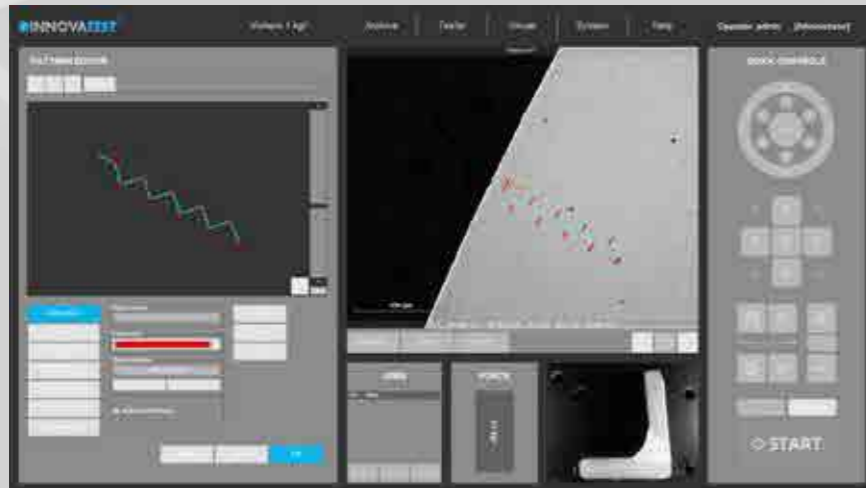

7 2D HARDNESS CHART

The application „Plane hardness chart“, is also referred to as Color Mapping happens to be the perfect tool for securing the detail of the effective hardness distribution over the total sample cross section of heat treated samples. An important feature in material exploration, weld testing or in damage analysis.

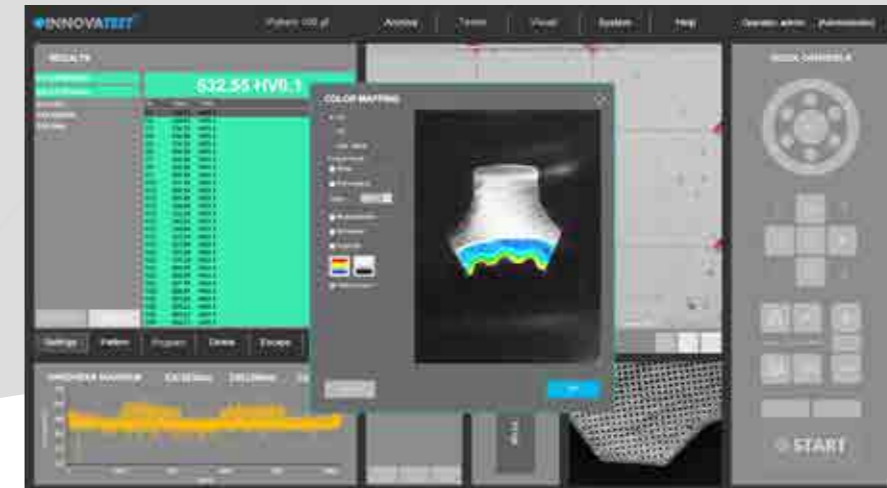

6 AUTOMATIC CONTOUR SCANNING

This application scans the entire outline (or partial) area of a sample. The function can be used with an objective by using the overview zoom camera for high speed scanning. The system scans the entire outline defined and stores all relevant data in the test program.

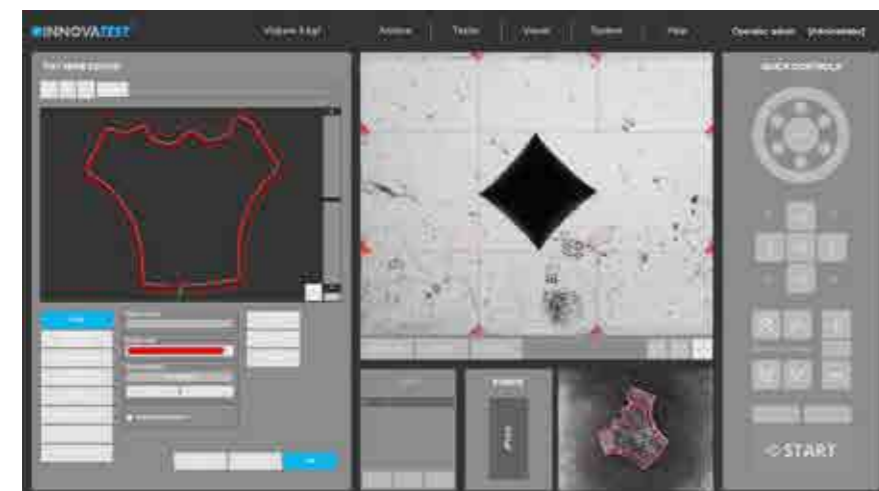

8 3D HARDNESS CHART

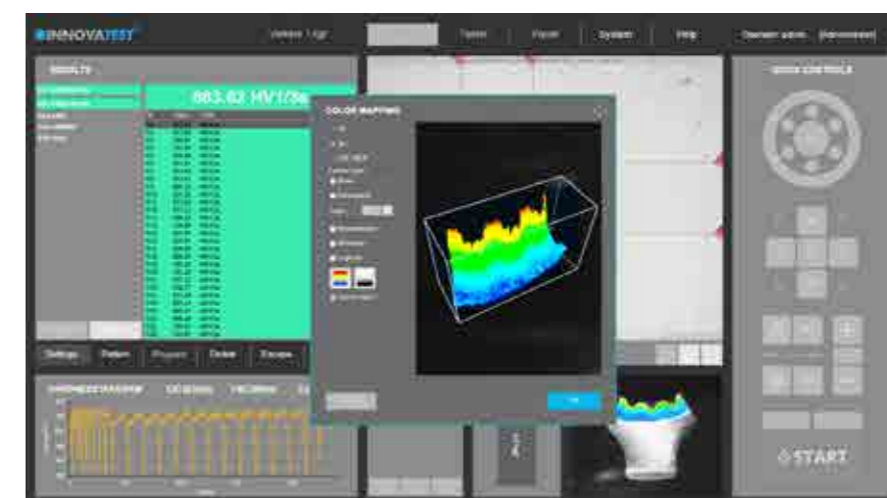

In addition to 2D graphic diagrams, the system can also automatically generate 3D diagrams. 2D and 3D hardness charts are included in one application.

Subsequently, a limitless number of test points can be inserted into the scanned image, or be set at selected distances (offset), relative to the edge. This advanced feature enables the hardness testing procedure to be performed c. An excellent featured combined with 2D or 3D hardness mapping, also known as “plane hardness chart”.

9 Kic CRACK MEASUREMENT

For those requiring more in depth knowledge on materials behavior, wishing to study material fracture and fatigue, crack growth can be predicted and measured by using the Kic application.

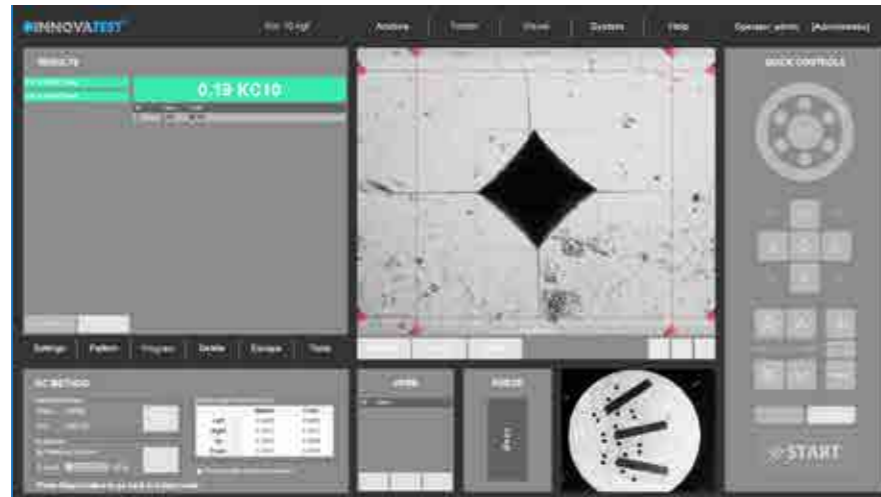

The software supports Kic crack detection under load with customized Kic result reporting. By way of one or both methods, Palmqvist or Median / Radial, fracture toughness is now a repeatable and reproducible test across multiple operators.

10 SNAPSHOT FUNCTION



This handy function in IMPRESSIONS™ allows you to make screen captures of the viewing area by way of objective view and/or Overview camera. It gives the opportunity to store such images with comments or to paste them into the report generator for further processing.

11 USER DEFINED PROGRAMS

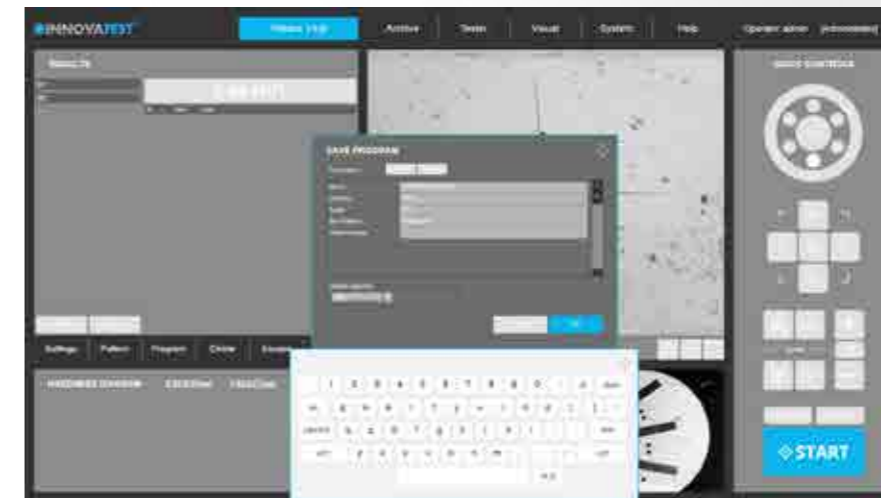

For repeating jobs, IMPRESSIONS™ utilizes the option of setting up and storing custom test programs. For each task, a "job" can be created. All application specific parameters, such as hardness scale, force, dwell-time, pattern, conversion and the report template are stored in the same program.

12 REPORT GENERATOR



Imagine having a report created for you that includes: Your company name, address, contact information, labeled results related to patterns or sequential, pictures of your optical measurements, stitched images, notes section for each result or pictures, rendition of the pattern performed, overview picture of your pattern on your sample, full statistics, summary of your results, go no-go results, Pass or fail...

All this information or having the ability to only have what you need reported, we call this our Report Configurator. You decide how much or how little you report by PDF or laser printer. We even keep it simple by choosing export to CSV file, to a thumb drive or network file location. Data management at its best!

MONITORING

Our world is going through processes that have influence on climate and environment. More often we see extreme heat, extreme cold and periods of extreme rain. To assure that such disturbances of nature do not coincidentally effect your measuring or testing results, we have prepared our machines to climate change and forces of nature.

13 VIBRATION & EARTH QUAKE MONITORING



The integrated high precision accelerometer electronics continuously monitor your tester's stability environment. While the tester has vibration isolators (machine dampers) installation environment is often not ideal. Think of heavy traffic, loaded fork lift trucks, excentre presses or other equipment making shop floor installation a base of trouble.

For certain countries/area's in the world where light earthquakes are so common that they are hardly noticed, the vibration monitoring system will give a warning message and stop the hardness testing process to avoid incorrect readings.

14 TEMPERATURE & HUMIDITY MONITORING



Extreme high or low temperatures might not only effect the hardness readings of your machine (think of installation in extremely warm countries or nearby furnaces) extreme humidity might even damage the sensitive electronics.

IDENTIFICATION

- 15 The basic function of the barcode reader is to load data in to determined user fields. The BAR | QR code module of INNOVATEST connects the machine to a database or network environment loading samples and data.



Whether simply inserting header files (single or serial) or the complete integration of reading devices for the automatic selection of database templates, retrieving data from connected ERP or quality systems (optional) QR and barcode readers simplify complicated work procedures for the operator.

In the above application, a turbo part has been engraved with a QR code. Extra challenging was the fact that the QR code was engraved in a high polished part of the turbo shaft.

All data for the particular turbo part was fixed in the underlying QR code. The scanner loads all customer data in the hardness testing machine and assures that the testing outcome is included in the particular test report database, fully automatic.

METALLOSCOPE™ METALLOGRAPHY SOFTWARE

The objectives on the 5100G2 make the hardness tester into an excellent highly automated metallographic microscope. Metallographic studies are of key importance in the manufacturing process of metals and steel, in the aerospace and automotive industry, in mechanical engineering, construction and in the manufacturing of a vast number of industrial and consumer products.

Microscopy is an indispensable feature of every metallographic lab, whether you investigate damages, develop novel alloy materials or perform quality control to ensure the purity of steel. The measurement of certain parameters such as volume fraction, coating thickness and grain size is specified in strict standards and norms.

Metallography is used to investigate metals from copper and titanium to iron, steel and alloys of every description. These investigations can now be performed quantitatively and reliably using the INNOVATEST Metalloscope™ 1 software module, running on most of our higher-end hardness testing machines*. *(features of Metalloscope™ 1 software depend on the particular tester model).

The microstructure of metals has a significant influence on properties such as strength and corrosion resistance. Therefore, a detailed investigation of the microstructure with the help of microscopy is central to metallographical disciplines as well as many industrial applications.

GRAIN SIZE



Grain size:
The grain size index can be calculated in various 1 or 2 dimensional way; using a 1-dimensional method (from the number of grain intercepts per mm) or a 2-dimensional method (from the number of grains per mm²). Line profile: 1-dimensional grain size index calculation by counting the number of grain intercepts on a line. Hexagonal grid: 2-dimensional grain size index calculation using a superimposed hexagonal grid or single grains calculation by counting the number of grains in a specific part of the image (blue box).

Hardness tester and metallurgical microscope.

Basic metals undergo specific treatment in order to prepare them for particular applications and to improve their characteristics, for example by adding alloying elements. In many cases, the microscopy investigation focusses on the correlation between the resulting microstructure and the material properties.

VOLUME FRACTION

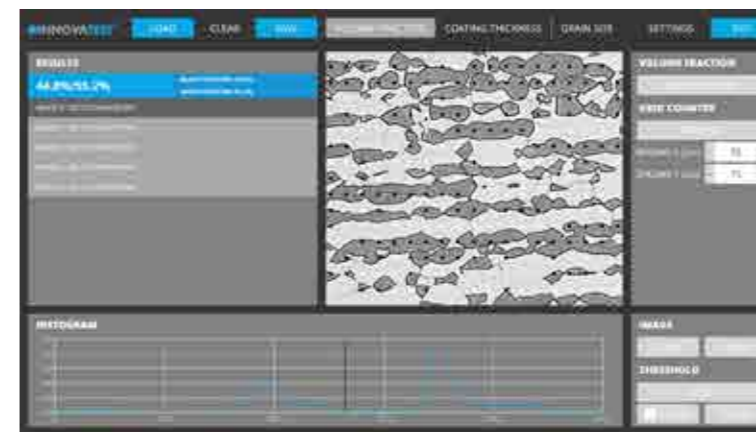

Volume fraction:
Various methods integrated; the example shows a sample consisting of ferrite (black material) and austenite (white material). Pixel counter: calculation based on histogram-guided image thresholding. Two automatic thresholding algorithms in addition to manual thresholding. Grid counter calculation using a superimposed grid. Each grid point can be assigned to the black material or white material. Initial values (black or white) are assigned automatically, but can be toggled manually. Grid positions are calculated by defining the number of grid points or the grid spacing.

COATING THICKNESS

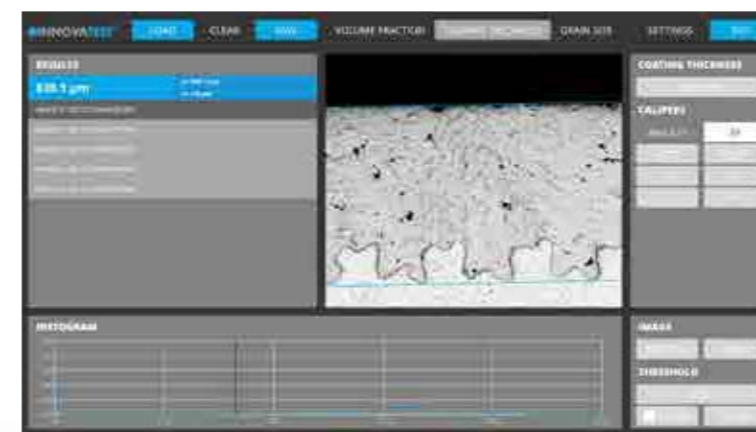

Coating thickness:
Calculate the thickness of a coating layer. This can be a single thickness or a mean thickness with standard deviation or a coating contour. Calculation using two parallel lines. The resulting coating thickness is the distance between these lines. Calipers can be rotated, automatic or manual. Coating contour: coating thickness calculation based on a number of measurement points. Contour edges are drawn semi-automatically and the number of measurement points can be selected by the user.

The NEMESIS 5100G2 is basically an upright, brightfield and darkfield microscope. Contrast methods of reflected light brightfield result are best suited to analyze the microstructures of etched surfaces. Recognizing grain boundaries, you can draw conclusions on grain sizes, phases and structural constituents. Impurities and structural constituents, such as graphite in cast iron, prior to etching are getting visible.

Reflected light darkfield shows up mechanical surface faults such as fracture sites, pores and inclusions as well as cracks, scratches and cavities. In combination with the NEMESIS 5100G2 automation, the system provides in maximum efficiency for both hardness testing and materials inspection.

AUTOMATIC IMAGE EVALUATION



AUTO FOCUS

Fast & precise, observe how IMPRESSIONS™ finds focus from a large distance, as far as the travel of the Z-axis allows. Algorithms used for close distance autofocusing set new standards in AF speed.



AUTOMATIC MEASUREMENT

Manual positioning of filar lines is no longer required. IMPRESSIONS™ refined measurement algorithms detect indents even on very poor or scratched surfaces and measure the relevant indent dimensions according to standards. Stay in control by switching to manual measure mode and have the option of adjusting measurements by touching the screen or using the mouse. Filar lines can be colored to give the best contrast against the specimen's surface. To assure that measurements meet relevant standards on symmetry, enable the automatic indent check. All hardness values can be converted to other scales according to ISO 18265, ISO 50150, ASTM E140.

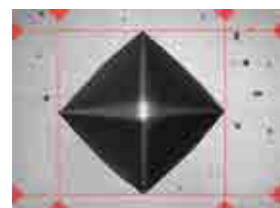

ILLUMINATION SETTINGS

IMPRESSIONS™ software automatic illumination system adapts to the correct illumination regardless of the sample surface quality, wherever on the sample, independent from material (steel, carbide, coated or ceramic). Contrast, Brightness and program, can be set automatically for each measurement or controlled manually. Sharpness can be stored with the pre-determined test.

Too bright

OK

Too dark



Irregular surface

Regular surface

Poor surface

Complex, refined algorithms ensure reproducible measurements on different materials and even on scratched and damaged surfaces.

SUPERIOR ARTIFICIAL INTELLIGENCE (AI)

We include an advanced physics development breakthrough in the image analyses of our Brinell capable hardness testing machines.

The conventional image processing methods on hardness testing machines are fairly successful for clean images that present clear indentation boundaries. In practice, however, workpieces or samples often have rough surfaces that compromise the quality of the image processing which could potentially result in incorrect hardness values.

A human observer can easily find the indentation in both images and the exact boundaries of such indentation (see fig. 1). For a computer algorithm, finding the indentation in the right image is much more challenging due to the many gradients in this image (see fig. 2). Artificial intelligence can overcome this difficulty by training a complex computer neural network to "think" as a human observer.

The INNOVATEST Brinell AI model is trained in our research facility/R&D department using powerful supercomputers. The training phase optimizes millions and millions of weight factors in a neural network, to learn how an indent can look like, using a gradient descent approach. Weight factors have been optimized by a human observer and after optimum weigh factors where determined. Using the AI function on our hardness tester to detect new indentations is called "inference" and requires significantly less computing power. The AI model has been created.

The integrated Intel® Core™ i7 processor can easily handle this task which makes it possible to install and use the INNOVATEST Brinell AI module on the NEMESIS 5100G2 as well.

During inference, a new image (a new Brinell indent image) is entered in to the neural network with weights that where determined during training (see fig. 3).

The complex algorithm is capable to calculate a "mask" on its own, this mask is plotted on top of the indent image, exactly filling the indent and marking the edges that then can be easily detected by automatic image recognition system (see fig. 4).

This super advanced technology requires no special objectives and provides even indents with poor visibility, often the case with shallow indents in rough surface materials, to be perfectly detected and measured.

The system is far superior to special objectives and standard Brinell measuring systems.

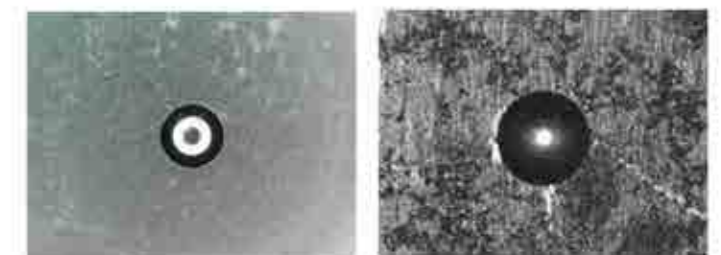

fig.1-2

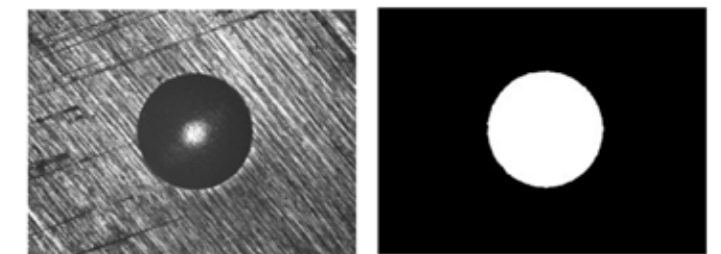
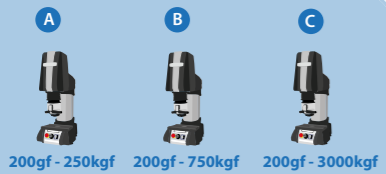

fig.3-4



STEP 1: Select machine type



200gf - 250kgf 200gf - 750kgf 200gf - 3000kgf

STEP 2: Additional force range

OPTION 1 10gf - 200gf

OPTION 2 250kgf - 750kgf

STEP 3: Indenter seats

1 Laser & touch probe



Cross laser



Touch probe



Touch probe laser

2 Indenter seats

10gf - (62.5kgf) (187.5kgf)

200gf - 62.5kgf

1kgf - 250kgf

3kgf - (750kgf) (3000kgf)

✓ = Standard included

STEP 4: Indenters

3 Indenters

A Rockwell

B Brinell

C Vickers

D Knoop

STEP 5: Optical

4 Overview camera

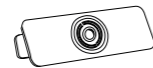

5 Objectives

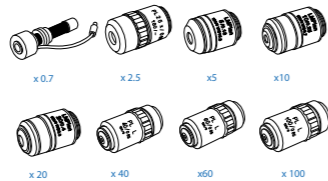

6 Ringlights



STEP 6: Stages/Anvils

7 Stages

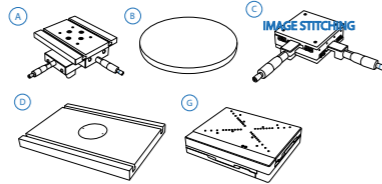

8 Anvils

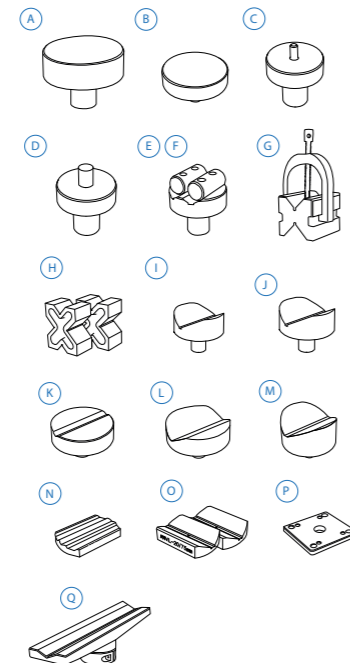

STEP 7: Sample holders

10 Sample holders

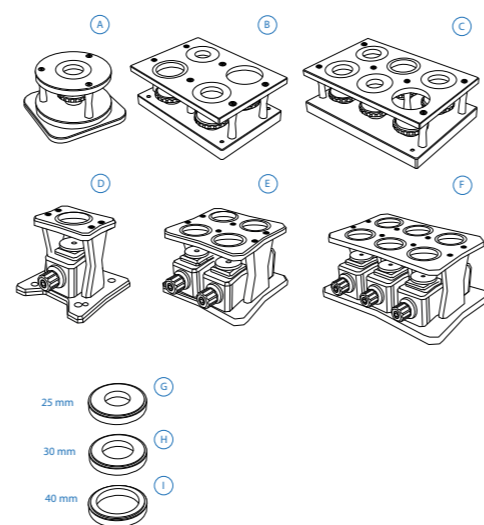

STEP 8: Fixtures & Vices

9 Fixtures & Vices

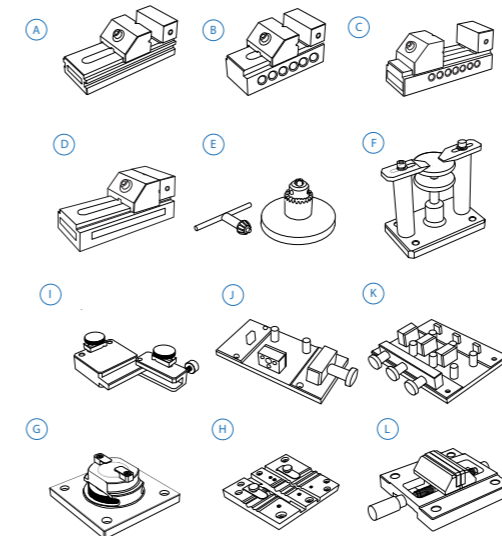

STEP 9: Software



MANUAL ON-SCREEN MEASUREMENT

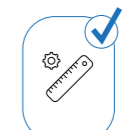

AUTOMATIC MEASUREMENT

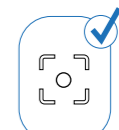

AUTOMATIC FOCUSING



REPORT GENERATOR

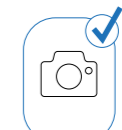

SNAPSHOT FUNCTION

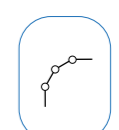

VIDEO OVERLAY PATTERN EDITOR

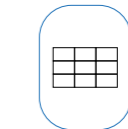
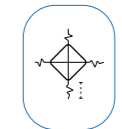
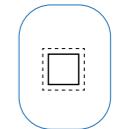

IMAGE STITCHING



KIC CRACK MEASUREMENT



AUTOMATIC CONTOUR SCANNING



2D / 3D HARDNESS CHART



DRAWING & MEASURING APPLICATION

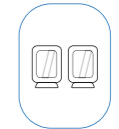

DUALVIEW TECHNOLOGY

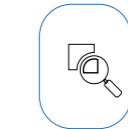

AUTOMATIC EDGE DETECTION



FORCE DEPTH/TIME DIAGRAM

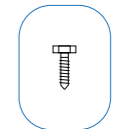

HARDNESS OF SCREW THREAD (ISO 898-1)



HARDNESS OF TAPPING SCREWS (ISO 2702)



USER LEVEL MANAGEMENT

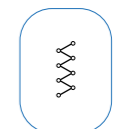

CHD, SHD, NHD CONFIGURATOR

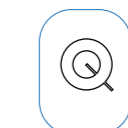

Q-DAS

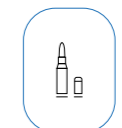

AMMUNITION TESTING PATTERN



WELD INSPECTION (ISO 9015)

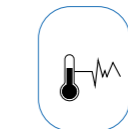

VIBRATION, TEMPERATURE & HUMIDITY MONITORING



AI SOFTWARE

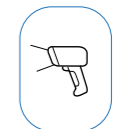

BARCODE & QR SOLUTIONS

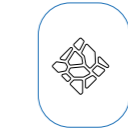

METALLOSCOPE SOFTWARE

✓ = Standard included

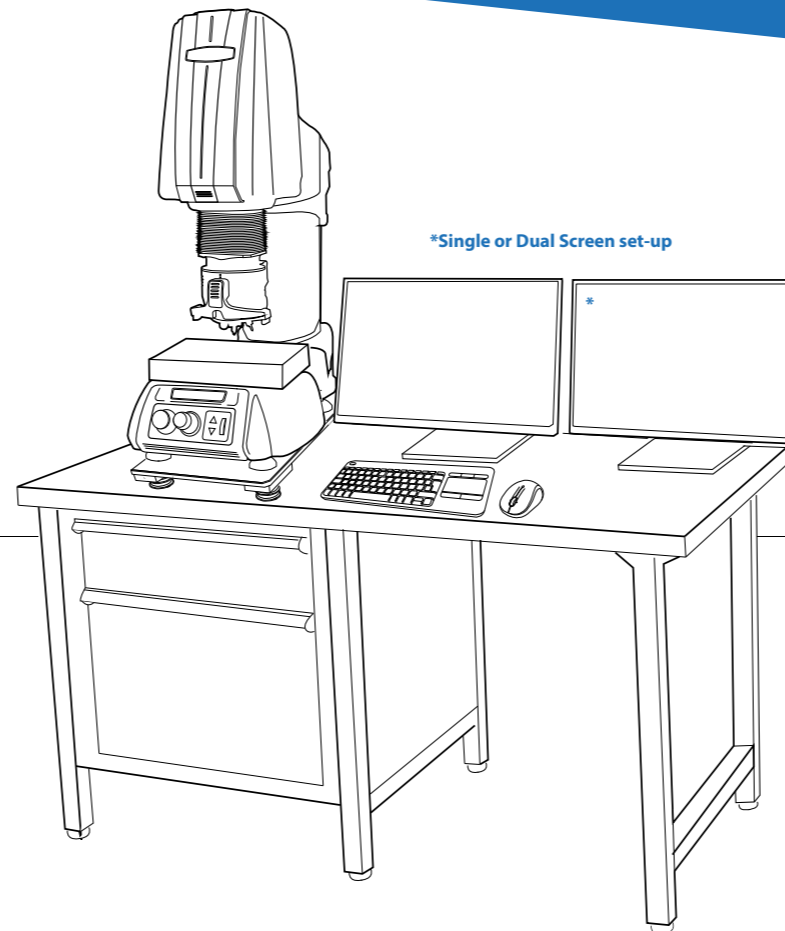

*Single or Dual Screen set-up

ORDER DETAILS

NEMESIS 5100G2



NEMESIS 5100G2/A Universal hardness tester, 200gf - 250kgf	NEMESIS 5100G2/A
NEMESIS 5100G2/B Universal hardness tester, 200gf - 750kgf	NEMESIS 5100G2/B
NEMESIS 5100G2/C Universal hardness tester, 200gf - 3000kgf	NEMESIS 5100G2/C
Option 1: Force range extension 10gf - 200gf	F5100G2O1
Option 2: Force range extension 250kgf - 750kgf, for 5100G2/A only	F5100G2O2
Plug & Play prepared, calibration, sea & airworthy packing in "non coniferous wood" material	P&PSEAPACK130

ACCESSORIES

STEP 3	Indenter seats				
1	Laser & touch probe	A	Cross laser & touch probe base	SA-05-0027	STANDARD
		B	Touch probe laser based, closed	SA-10-0036	STANDARD
		C	Touch probe laser based, open	SA-10-0045	STANDARD
2	Indenter seats	A	Indenter seat 3mm, 10gf - (62.5 kgf) (187.5kgf)	SA-10-0030	
		B	Indenter seat 6.35mm, 200gf - 62.5kgf	SA-10-0035	
		C	Indenter seat 6.35mm, 1kgf - 250kgf	SA-10-0034	
		D	Indenter seat 6.35mm, 3kgf - (750kgf) (3000kgf)	SA-10-0033	
			Indenter seat adjustment base, mounting set (1 for each SA-0030, 33, 34 & 35)	SA-10-0031	
			Fixed indenter seat base, mounting set (min. 1 required)	SA-10-0032	
STEP 4	Indenters				
3	Rockwell	A	Rockwell C Diamond Indenter, ISO & ASTM certified	IN/6005	
			Rockwell Ball Indenter 1/16". Includes 1 carbide ball, ISO & ASTM certified	IN/7506	
			Rockwell Ball Indenter 1/8". Includes 1 carbide ball, ISO & ASTM certified	IN/7606	
			Rockwell Ball Indenter 1/4". Includes 1 carbide ball, ISO & ASTM certified	IN/7706	
			Rockwell Ball Indenter 1/2". Includes 1 carbide ball, ISO & ASTM certified	IN/7806	
	Brinell	B	Brinell Indenter 1mm. Includes 1 carbide ball. Ø6.35mm. ISO & ASTM certified	IN/7000	
			Brinell Indenter 1mm. Includes 1 carbide ball. Ø3mm. ISO & ASTM certified	IN/7001	
			Brinell Indenter 2.5mm. Includes 1 carbide ball. Ø6.35mm. ISO & ASTM certified	IN/7005	
			Brinell Indenter 2.5mm. Includes 1 carbide ball. Ø3mm. ISO & ASTM certified	IN/7006	
			Brinell Indenter 5mm. Includes 1 carbide ball. Ø6.35mm. ISO & ASTM certified	IN/7010	
	Vickers		Brinell Indenter 5mm. Includes 1 carbide ball. Ø3mm. ISO & ASTM certified	IN/7011	
			Brinell Indenter 10mm. Includes 1 carbide ball. Ø6.35mm. ISO & ASTM certified	IN/7015	
		C	Macro Vickers Indenter Ø6.35mm, ISO & ASTM certified	IN/8010	
			Micro Vickers Indenter Ø3mm, ISO & ASTM certified	IN/8105	
		Knoop	D	Micro Knoop Indenter Ø3mm, ISO & ASTM certified	IN/8205
	Macro Knoop Indenter Ø6.35mm, ISO & ASTM certified		IN/8220		
STEP 5	Optical				
4	Overview camera		Overview / Full view zoom camera + software functionality, field of view 57x60mm up to 225x180mm, Includes overview lights	CE-22-0148	
5	Objectives		0.7x Objective for Brinell	AS9000-0.7OBJ	
			2.5x Long Working Distance objective	ASSUN-OBJ2.5X	
			5x Long Working Distance objective	ASSUN-OBJ5X	
			10x Long Working Distance objective	ASSUN-OBJ10X	

			20x Long Working Distance objective	ASSUN-OBJ20X		
			40x Long Working Distance objective	ASSUN-OBJ40X		
			60x Long Working Distance objective	ASSUN-OBJ60X		
			100x Long Working Distance objective	ASSUN-OBJ100X		
			Adjustable objective socket 2.5x - 100x (1x required for each objective)	SA-05-0025		
			Adjustable objective socket 0.7x (required for 0.7 objective)	SA-05-0026		
6	Ringlights	A	Crystal™ Clear LED ring light, multi use for 0.7x objectives	SA-05-0020		
		B	Crystal™ Clear LED ring light, multi use for 2.5x objectives	SA-05-0021		
		C	Crystal™ Clear LED ring light, multi use for 5x objectives	SA-05-0022		
STEP 6	Stages/Anvils					
7	Stages	A	Manual X-Y stage with analogue metric micrometers, 180x160mm Displacement: 25x25mm, scale 0.01mm, max load 300kg	UN-TESTTABLE/030		
			Lock flange	UN-XYZ BUSH50		
			Mounting plate for lock flange	UN-XYZ30FP50-55		
			Quick change anvil base (required for mounting testing tables, anvils)	AS5000-450		
			B	Testing table flat ø200mm, screwfix	UN-TESTTABLE/010	
			Testing table flat ø235mm, screwfix	UN-TESTTABLE/012		
			Testing table Ø200mm (61 - 65HRC) requires lock flange	CM-08-0194		
			C	Manual X-Y stage with analogue metric micrometers, 100x100mm. Displacement: 25x25mm, scale 0.01mm, max load 100kg	UN-XYSTAGE-120	
			D	Large flat surface testing table 350x250mm, thickness 30mm with 2 T-slots, for large components	UN-TESTTABLE/015	
			Large flat surface testing table 450x350mm, thickness 35mm with 2 T-slots, for large components	UN-TESTTABLE/016		
			E	Digital micrometer, for manual X-Y stage, Displacement: 25mm, resolution 0.001mm	IMP-DIGMIC	
			F	Manual iSMART™ stage, 150x150mm, Displacement: 50x50mm	BM-08-0057	
			Digital control unit for Manual iSMART™ stage, 25mm travel	BM-08-0058		
			Digital control unit for Manual iSMART™ stage, 50mm travel	BM-08-0059		
			G	iSMART™ motorized CNC X-Y stage, 215x160mm, total load up to 400Kgf max. Displacement: 75x75mm, resolution 0.001mm, repeatability+/-0.015mm	MA-XY7575S	
	iSMART™ stage, 260x205mm, total load up to 400Kgf max. Displacement: 120x120mm, resolution 0.001mm, repeatability+/-0.015mm	MA-XY1212S				
	iSMART™ stage, 360x205mm, total load up to 400Kgf max. Displacement: 220x120mm, resolution 0.001mm, repeatability+/-0.015mm	MA-XY2212S				
	iSMART™ stage, 490x224mm, total load up to 400Kgf max. Displacement: 340x120mm, resolution 0.001mm, repeatability+/-0.015mm	MA-XY3412S				
	iSMART™ stage, 410x265mm, total load up to 4000Kgf max. Displacement: 200x150mm, resolution 0.001mm, repeatability+/-0.015mm	MA-XY2015S				
	iSMART™ stage, 510x265mm, total load up to 4000Kgf max. Displacement: 300x150mm, resolution 0.001mm, repeatability+/-0.015mm	MA-XY3015S				
	iSMART™ stage, 560x265mm, total load up to 4000Kgf max. Displacement: 400x150mm, resolution 0.001mm, repeatability+/-0.015mm	MA-XY4015S				
	Motorized CNC X-Y stage, 257x188mm, total load up to 400Kgf max Displacement: 120x120mm, resolution 0.001 mm, repeatability+/-0.003mm	UN-XY571212TT				
	Motorized CNC X-Y stage, 307x208mm, total load up to 400Kgf max Displacement: 170x120mm, resolution 0.001mm, repeatability+/-0.003mm	UN-XY571712TT				

			Motorized CNC X-Y stage, 357x208mm, total load up to 400Kgf max Displacement: 220x120mm, resolution 0.001mm, repeatability +/- 0.003mm	UN-XY572212TT	
			Motorized CNC X-Y stage, 337x238mm, total load up to 400Kgf max. Displacement: 200x150mm, resolution 0.001mm, repeatability +/- 0.003mm	UN-XY902015	
			Motorized CNC X-Y stage, 437x238mm, total load up to 450Kgf max. Displacement: 300x150mm, resolution 0.001mm, repeatability +/- 0.003mm	UN-XY903015	
			Motorized CNC X-Y stage, 630x238mm, total load up to 450Kgf max Displacement: 400x150mm, resolution 0.001mm, repeatability +/-0.003mm	UN-XY904015	
			Motorized CNC X-Y stage, 410x280mm, total load up to 4000Kgf max. Displacement: 200x150mm, resolution 0.001mm, repeatability +/- 0.008mm	UN-XY932015	
			Motorized CNC X-Y stage, 510x280mm, total load up to 4000Kgf max. Displacement: 300x150mm, resolution 0.001mm, repeatability +/- 0.008mm	UN-XY933015	
			Motorized CNC X-Y stage, 630x238mm, total load up to 4000Kgf max. Displacement: 400x150mm, resolution 0.001mm, repeatability +/- 0.008mm	UN-XY934015	
	<i>Cable sets, mounting & Connectivity for motorized stage</i>		Dove tail mounting plate, for UN motorized stages	CM-08-0033	
			Cable set for connecting CNC stage to embedded driver (1 set for 2-axis) 105cm	UN-XY2CABLENBS	
8	Anvils	A	Flat anvil 60mm	AS3000-19-04	
		B	Flat anvil 80mm	UN-TESTTABLE/002	
		C	Spot anvil 5mm	UN-ANVIL/010	
		D	Spot anvil 10mm	UN-ANVIL/011	
		E	Cylindrical V anvil 6-80mm	UN-CVANVIL680	
		F	Cylindrical V anvil 50-200mm	UN-CVANVIL50200	
		G	V block with bracket 40x40x50mm (LxBxH)	UN-VBLOCK404050	
		H	Steel, cross type, (X) V-block 60x120x100mm 8-90mm pair	UN-CROSSBLOCK01	
		I	V-anvil ø40mm 6-60mm	UN-ANVIL/005	
		J	V-anvil ø63mm 10-100mm	UN-ANVIL/006	
		K	V-Anvil ø80mm 3.3-20mm	UN-ANVIL/040	
		L	V-Anvil ø80mm 12-80mm	UN-ANVIL/045	
		M	V-Anvil ø80mm 20-140mm	UN-ANVIL/050	
			Test table 100x100mm, V groove 20mm wide, 10mm deep	UN-TESTTABLE/040	
		N	Small V-Anvil 3-20mm requires base plate (Requires Manual/Autom. X-Y stage)	UN-ANVILSV/105	
		O	Large V-Anvil 20-75mm requires base plate (Requires Manual/Autom. X-Y stage)	UN-ANVILLV/106	
		P	Base plate for V-anvils, UN-ANVILSV/105 & UN-ANVILLV/106	UN-VANVILBASEPL	
		Q	Extra long V-Anvil (Ø10 - Ø100)	CM-08-0186	
	<i>Clamping, locking & fixing adapters</i>		Quick change anvil base (required for mounting testing tables, anvils)	AS5000-450	
			Lock flange	AS9000-21-01	
STEP 7	Sample holders				
10	Sample holders	A	1 position sample holder, for 1 embedded sample, diameter 50mm or 2"	UN-ESH1	
		B	4 position sample holder, for max. 4 embedded samples, diameter 50mm or 2"	UN-ESH4	
		C	6 position sample holder, for max. 6 embedded samples, diameter 50mm or 2"	UN-ESH6	
		D	1 position sample holder, for 1 embedded sample, diameter 50mm or 2" with front operation elevator knob	BM-08-0052	

		E	4 position sample holder, for max. 4 embedded samples, diameter 50mm or 2" with front operation elevator knob	BM-08-0053	
		F	6 position sample holder, for max. 6 embedded samples, diameter 50mm or 2" with front operation elevator knob	BM-08-0054	
			12 position sample holder, for max. 12 embedded samples, diameter 50mm or 2" with front operation elevator knob	BM-08-0056	
		H	1 insert reduction ring 25mm	UN-ESHI25	
		I	1 insert reduction ring 40mm	UN-ESHI40	
			1 insert reduction ring 1"	UN-ESHI1	
			1 insert reduction ring 1 1/4"	UN-ESHI125	
			1 insert reduction ring 1,5"	UN-ESHI15	
STEP 8	Fixtures & vices				
11	Fixtures & vices	A	Polished precision vice with lock down system, jaw width 25mm, opens 20mm	UN-VICE/210	
		B	Polished precision vice with lock down system, jaw width 36mm, opens 42mm	UN-VICE/215	
		C	Polished precision vice with lock down system, jaw width 48mm, opens 75mm	UN-VICE/220	
		D	Polished precision vice with lock down system, jaw width 75mm, opens 100mm	UN-VICE/230	
		E	Axle chuck 500 series for cylinder parts, dia. 0.4mm to 5mm	UN-AXLECHUCK	
		F	Universal Clamp & Leveling Device	UN-CLAMP/105	
		G	Thin metal clamp	UN-CLAMP/115	
		H	V groove clamp for small round parts dia.0.8-5mm	UN-VGROOVE- CLAMP	
		I	Wire Testing Fixture for specimen dia. 0.8-3.5mm	UN-WIRE/105	
		J	JOMINY Fixture, for 1 quench end test sample, quick release function	UN-JOMFIX1	
		K	JOMINY Fixture, for 3 quench end test sample, quick release function	UN-JOMFIX3	
		L	Small parts vice jaw width 55mm, open 50mm, self centering	UN-VICE/115	
STEP 9	Software				
	Additional software		Manual on-screen measurement	UN-MANM	STANDARD
			Automatic measurement	UN-AUTOM	STANDARD
			Automatic focussing	UN-AUTOFOC	STANDARD
			Report configurator	UN-REPORTA	STANDARD
			Snapshot function	UN-SNAPSH	STANDARD
			Advanced 3 axis coordinate & free style indent pattern configurator, for motorized stage only	UN-TESTPAT01	
			Advanced 3 axis coordinate & free style indent pattern configurator, + CHD, SHD, NHD and edge detection, (supports manual & digital micrometer stages only)	UN-TESTPAT02	
			Image stitching, composes full stage overview, and detailed sample overview in high resolution. Requires a motorized stage.	UN-IMST01	
			KiC crack detection under load. Palmqvist & Median / Radial fracture toughness	UN-CRKPAP	
			Automatic Contour scanning	UN-CSCAN	
			2D / 3D hardness scanning (mapping, includes automatic contour scanning)	UN-CSCAN2D3D	
			Drawing and measuring (distance & angles) application	UN-DRMEAS	
			DualView Technology, 2 viewing screens software, screen, cables, Europe and US power cable included, 24" Industrial LCD screen included	UN-DVTECHSET24	
			Automatic edge detection	UN-EDGEDTC	
			Force depth/time diagram	UN-FDDIAGR	

		ISO898-1 screw thread measurement of (de)-carbonized part. Requires UN-CSCAN	UN-ISO898/1	
		ISO-2702 tap screw thread measurement	UN-ISO2702	
		User level management	UN-LEVMAN	STANDARD
		CHD, SHD, NHD configurator & graphic interface for analogue and digital micro meter stage only (not including full pattern editor)	UN-MCHD	
		CHD, SHD, NHD configurator & graphic interface requires: indent pattern configurator (TESTPAT01)	UN-PATCHD	
		Q-DAS Certified connectivity protocol	UN-QDAS	
		Advanced 3-axis communication protocol for robotic systems	UN-REMC	
		ISO bullets casings pattern configurator and reporting system	UN-SHELLCONF	
		ISO 9015 Weld pattern configurator (automatic weld pattern configurator), requires overview camera or AS9000-0.7OBJ	UN-WELDPAT	
		Vibration, temperature & humidity monitoring	UN-VIBCLC	
		Artificial Intelligence Deep Learning Brinell module	UN-AIDLBO1	STANDARD
		Barcode & QR data mapping software	UN-SCANFLOW	
		Metalloscope™ Metallogy software pack	UN-MSCPV1	
Connectivity plus		Powerfull external intel core i7 pc, with 16gb ram, and 512gb ssd drive Windows 10 pre-installed including wiring and integration with tester.	UN-SYSPCIMP01	
		Bluetooth connectivity	UN-BTADAPT	
		Utility software; Import test results in MS applications like Excel	UN-SW/905	
		USB to USB null modem cable 2.5M	BE-99-0025	
		Wireless system Keyboard & wireless mouse	UN-SKBSET	STANDARD
		Virtual joystick, on screen		STANDARD
Additional items				
Machine stands	A	Cabinet test table with drawer for hardness testers 71x75x80cm	UN-STAND/960	
	B	Cabinet test table with drawer for hardness testers 150x75x80cm	UN-STAND/965	
		Seaworthy packing box for 950/960	PACK/100	
		Seaworthy packing box for 965	PACK/200	
Vibration isolation stage		Passive vibration isolation stage, broad spectrum	UN-AVS-300	
Printer		Laser Printer	UN-PRINT	
Projector		On request, any brand of choice	UN-PROJECTOR	
ISO 17025 UKAS ISO / ASTM Calibration		BRINELL direct and indirect calibration & certification, traceable, in compliance with ISO & ASTM, NADCAP. Includes direct force and indirect verification report (block readings), report, flat fee for selected common scales, per scale.	CCERTUKAS/1B	
ISO 17025 UKAS ISO / ASTM Calibration		VICKERS direct and indirect calibration & certification, traceable, in compliance with ISO & ASTM, NADCAP. Includes direct force and indirect verification report (block readings), report, flat fee for selected common scales, per scale.	CCERTUKAS//1V	
ISO 17025 UKAS ISO / ASTM Calibration		KNOOP direct and indirect calibration & certification, traceable, in compliance with ISO & ASTM, NADCAP. Includes direct force and indirect verification report (block readings), report, flat fee for selected common scales, per scale.	CCERTUKAS/1K	
ISO 17025 UKAS ISO / ASTM Calibration		ROCKWELL direct and indirect calibration & certification, traceable, in compliance with ISO & ASTM, NADCAP. Includes direct force and indirect verification report (block readings), report, flat fee for selected common scales, per scale.	CCERTUKAS/1R	
Cover		Machine cover 600x700x1000mm	UN-COVER5	
Joystick		3-axis joystick, with fine adjustment and dynamic axis control	UN-JOYSTICK1	

ACCESSORIES

INDENTER SEATS

Laser & touch probe



Indenter seats



INDENTERS

Indenters



OPTICAL

Overview camera



CE-22-0148

Objectives



Objectives



STAGES/ANVILS

Stages



STAGES/ANVILS

Stages



Wired stages

UN-XY571212TT	UN-XY904015
UN-XY571712TT	UN-XY932015
UN-XY572212TT	UN-XY933015
UN-XY902015	UN-XY934015
UN-XY903015	

iSMART™ stages

MA-XY3412S	MA-XY4015S
MA-XY7575S	MA-XY2015S
MA-XY1212S	MA-XY3015S
MA-XY2212S	MA-XY4015S

Anvils

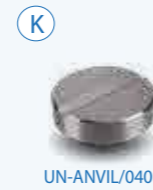

SAMPLE HOLDERS

Sample holders - Regular model



UN-ESH1
UN-ESH4
UN-ESH6



Sample holders - Front operation



BM-08-0052
BM-08-0054
BM-08-0056

FIXTURES & VICES

Fixtures & vices



ADDITIONAL ITEMS

Machine stands

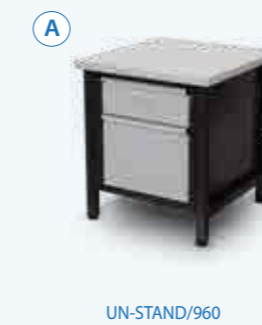

Vibration isolation stage



SPECIFICATIONS

HARDNESS SCALES

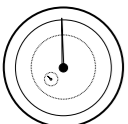
	ROCKWELL	Regular Rockwell scales; Pre Load 10kgf, Main Load 60kgf 100kgf 150kgf A B C D E F G H K L M P R S V
	EN-ISO 6508 ASTM E-18 JIS Z 2245	Superficial Rockwell scales; Pre Load 3kgf, Main Load 15kgf 30kgf 45kgf 15N 30N 45N 15T 30T 45T 15W 30W 45W 15X 30X 45X 15Y 30Y 45Y
	VICKERS	HV0.010, HV0.015, HV0.020, HV0.025, HV0.050, HV0.1, HV0.2, HV0.3, HV0.5, HV1, HV2, HV2.5, HV3, HV4, HV5, HV10, HV20, HV25, HV30, HV40, HV50, HV60, HV100, HV120, HV150
	ISO 6507 ASTM E384, E92 JIS B 7725	
	Kic Fracture toughness	All Vickers forces & scales
	KNOOP	HK0.01, HK0.02, HK0.025, HK0.05, HK0.1, HK0.2, HK0.3, HK0.5, HK1, HK2, HK5
	ISO 4545 ASTM E92 JIS Z 2251	
	BRINELL	HBW1/1 HBW1/1.25 HBW1/2.5 HBW1/5 HBW1/10 HBW1/30 HBW2.5/6.25 HBW 2.5/78125 HBW2.5/15.625 HBW2.5/31.25 HBW2.5/62.5 HBW2.5/187.5 HBW5/25 HBW5/31.25 HBW5/62.5 HBW5/125 HBW5/250 HBW5/750 HBW10/100 HBW10/125 HBW10/250 HBW10/500 HBW10/1000 HBW10/1500 HBW10/3000
	ISO 6506, ASTM E10 JIS Z 2243	
	HVD (HVT)	HV5 HV10 HV20 HV30 HV50 HV100 HV120
	VDI/VDE 2616-1	
	HBD (HBT)	HBW1/5 HBW1/10 HBW1/30 HBW2.5/6.25 HBW2.5/15.625 HBW2.5/31.25 HBW2.5/62.5 HBW2.5/187.5 HBW5/25 HBW5/125 HBW5/250 HBW5/750 HBW10/100 HBW10/500 HBW10/1000 HBW10/1500 HBW10/3000
	VDI/VDE 2616-1	
	PLASTIC	49,03 N, 132,9 N, 357,9 N, 961 N
	ISO 2039	
	CARBON	HR 2,5/7 HR 5/7 HR 5/15 HR 5/20 HR 5/40 HR 5/60 HR 5/100 HR 5/150 HR 10/20 HR 10/40 HR 10/60 HR10/100 HR 10/150
	CONVERSIONS	Conversion to other hardness scales according to ASTM E140, ISO 18265, GB/T 1172

TEST FORCE

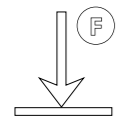
	Force application	Servo drive, precision gearbox, motion & torque feedback system
		Multi-load cell, closed loop, force feedback
	Test forces	10gf – 3000kgf
	Force range per model	NEMESIS 5100G2 A 200gf - 250kgf NEMESIS 5100G2 B 200gf - 750kgf NEMESIS 5100G2 C 200gf - 3000kgf
	Optional force ranges	OPTION 1 10gf - 200gf OPTION 2 250kg - 250kgf
	Test force tolerance	< 0.25% for test force 100gf to 3000kgf < 0.5% for test force below 100gf
	Dwell time settings	Default 10 seconds, user defined. Up to 999 seconds

MOTORIZED TOOL CHANGER

	Motorized tool changer (turret)	Ultra-fast, 9 position, 8 free to configure, 1 fixed
	Free tool positions	8 for indenters, 8 for objectives (8 max total)
	Fixed tool positions	1 for cross laser & touch probe
	Objectives	Long working distance 0.7x, 2.5x, 5x, 10x, 20x, 40x, 60x, 100x
	Indenters	Certified indenters (ISO/ASTM) available at choice
	Camera 1 (objective)	18 Mpx, HD, 4K+, Machine vision system
	Camera 2 (overview)	18 Mpx Full HD, Full Color, Optical zoom system, variable FOV 40 x 30mm - 140 x 110mm

SYSTEM

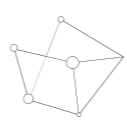
	Electronic system Standard (Recommended)	High performance embedded controller, i7 mSSD, 120 GB MS Windows® 10 operated, up to 8 years* INNOVATEST warranty
	Electronic system (Optional)	High performance external controller, i7 or i9 SSD, 1TB MS Windows® 10 operated, 1 year factory warranty
	Screen(s)	27" capacitive touchscreen, optional 27" or 2 x 24" (touch)screens (all landscape)
	Display resolution	0.01 HV, HK, HB
	Statistics	Total test, max, min, average, range, standard deviation, All in real time after each test
	Hardness conversion	Rockwell, Rockwell Superficial, Vickers, Brinell, Knoop, Leeb & Tensile
	Software	IMPRESSIONS™ V4, work flow system & tester control
	Data storage capacity	Internal and external mSSD, SSD or HDD
	Data output	XML, CSV, Certified for Q-DAS (optional)
	Data input	Keyboard, touchscreen, barcode scanner, database
	Connectivity	5 USB ports, RJ45 Ethernet LAN, W-LAN, RS-232, Blue Tooth, 5 Axis CNC & motorized XY-stage connector, Dual HDMI screen connectors
	Printer	A4, A3 full color laser printer (optional)

GENERAL

	Machine dimension	1100mm x 425mm x 695mm
	Machine weight	180 kg
	Workpiece accommodation	150mm (H) x 230mm (D)
	Power supply	100VAC to 240VAC, 50/60Hz, single phase
	Operating temperature	10°C to 35°C
	Power consumption	100W
	Humidity	10% to 90%, non-condensing
	Noise	< 70 db(A)

* Check individual warranty conditions

BATCH PRODUCTION



TECHNICAL DRAWINGS

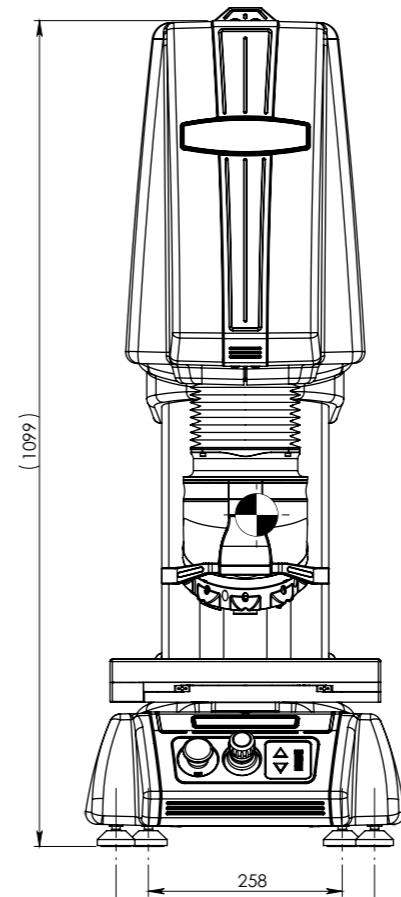

All dimensions in these drawings are in mm, approximate. Working heights and or workpiece accommodation varies depending on the stages and stage accessories used.

Please contact our sales department for more details.

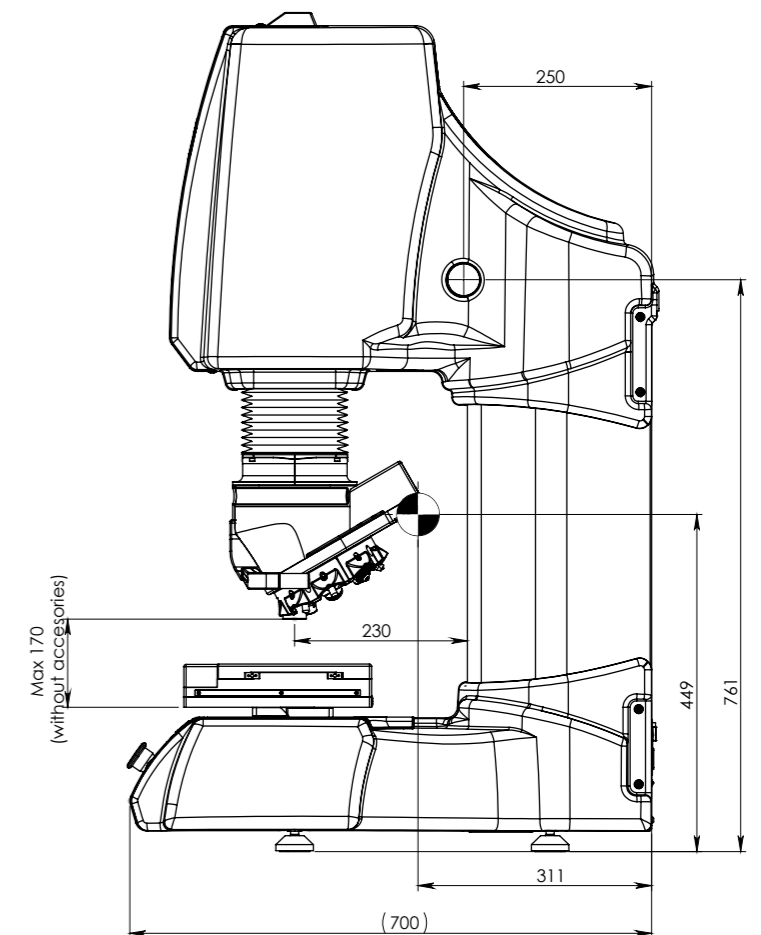
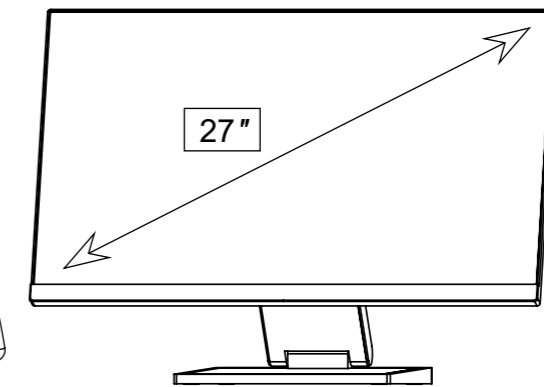

OTHER MODELS IN THE UNIVERSAL RANGE



NEXUS 605U

Fully automatic, load cell, Closed loop, force feedback universal hardness tester with electronic micrometer or analogue eyepiece. I-TOUCH™, 6.5" full color touchscreen.
See brochure B19N605U/XX



VERZUS 750U

Fully automatic, load cell, Closed loop, force feedback universal hardness tester with electronic micrometer or analogue eyepiece. IMPRESSIONS™ 8.5" full color touchscreen.
See brochure B19V750U/XX



FENIX 300U

Load Cell, Closed loop, force feedback, test force application system Universal hardness tester with I-TOUCH™ system.
See brochure B20F300/XX



NEXUS 8100XL

Heavy duty fully automatic, load cell, closed loop, force feedback universal hardness tester with full HD optical zoom stage overview camera, IMPRESSIONS™ 15" full color touchscreen.
See brochure B19N8100/XX



NEMESIS 9600

Heavy duty fully automatic, load cell, closed loop, force feedback universal hardness tester with full HD optical zoom stage overview camera, IMPRESSIONS™ 15" full color touchscreen.
See brochure B19N9600/XX



NEXUS 7700

Fully automatic, load cell, closed loop, force feedback universal hardness tester with full HD optical zoom stage overview camera, IMPRESSIONS™ 12" full color touchscreen.
See brochure B19N7700/XX



NEMESIS 9100

Multi Load Cell, Closed loop Fully automatic, 8 position turret Rockwell, Superficial Rockwell, Micro/Macro Vickers, Knoop & Brinell Hardness testers Descending test head, fixed work piece position
See brochure B18N9100/XX



NEXUS 8100

Heavy duty fully automatic, load cell, closed loop, force feedback universal hardness tester with full HD optical zoom stage overview camera, IMPRESSIONS™ 15" full color touchscreen.
See brochure B19N8100/XX

www.innovatest-europe.com

Changes in products and/or product specifications can emerge due to new technologies and continuous development.

We reserve the right to change or modify specifications of the products without prior notice. We recommend you to contact our sales office for up-to-date information.

Brochure B22N5100G2/03/EN

© All rights reserved, 2022

EUROPE

INNOVATEST Deutschland GmbH. Sales & Service

Phone: +49 245 670 59 500
info@innovatest-deutschland.com
www.innovatest-deutschland.com

INNOVATEST France SARL Sales & Service

Phone: +33 1 848 88038
commercial@innovatest-france.com
www.innovatest-france.com

INNOVATEST UK Ltd. Sales & Service

Phone: +44 (0) 121 824 4775
info@innovatest-uk.com
www.innovatest-uk.com

INNOVATEST Polska sp. z o.o Sales & Service

Phone: +48 697 099 826
info@innovatest-polska.pl
www.innovatest-poland.com

NORTH-AMERICA

INNOVATEST USA Inc. Sales & Service

Phone: +1 267 317 4300
info@innovatest-usa.com
www.innovatest-usa.com

ASIA

INNOVATEST Shanghai Co., Ltd. Sales & Service

Phone: +86 21 60906200
Fax: +86 21 60912595
info@innovatest-shanghai.com
www.innovatest-shanghai.com

INNOVATEST Japan Co., Ltd. Sales & Service

Phone: +81 3 3527 3092
Fax: +81 3 3527 3093
info@innovatest-japan.com
www.innovatest-japan.com

INNOVATEST South East Asia Sales & Service

Phone: +65 6451 1123
Fax: +65 6452 1011
info@innovatest-singapore.com
www.innovatest-singapore.com

Distributor :

CORPORATE HEAD OFFICE

INNOVATEST Europe BV

Manufacturing, Distribution & Service

Borgharenweg 140
6222 AA MAASTRICHT
The Netherlands

Phone: +31 43 3520060
Fax: +31 43 3631168
info@innovatest-europe.com
www.innovatest-europe.com