

# NEMESIS 6200

Rockwell | Brinell Hardness Tester

FULLY **AUTOMATIC**



# NEMESIS 6200

## Your goals don't scare us...

The 6200 Series hardness tester is a state-of-the-art machine. It features an all linear force application system, with a descending test head and a fixed work piece position. This eliminates, for 100%, any unwanted tolerance in the depth measurement.

The 6200 model features Load cell, force feedback, closed loop system, fully automatic, servo motor driven. This hardness tester can accommodate a wide variety of applications due to the IMPRESSIONS™ advanced hardness software. Perfectly suitable for aircraft engine parts, automobile parts, production lines, general quality assurance and the highest standard for laboratory use.

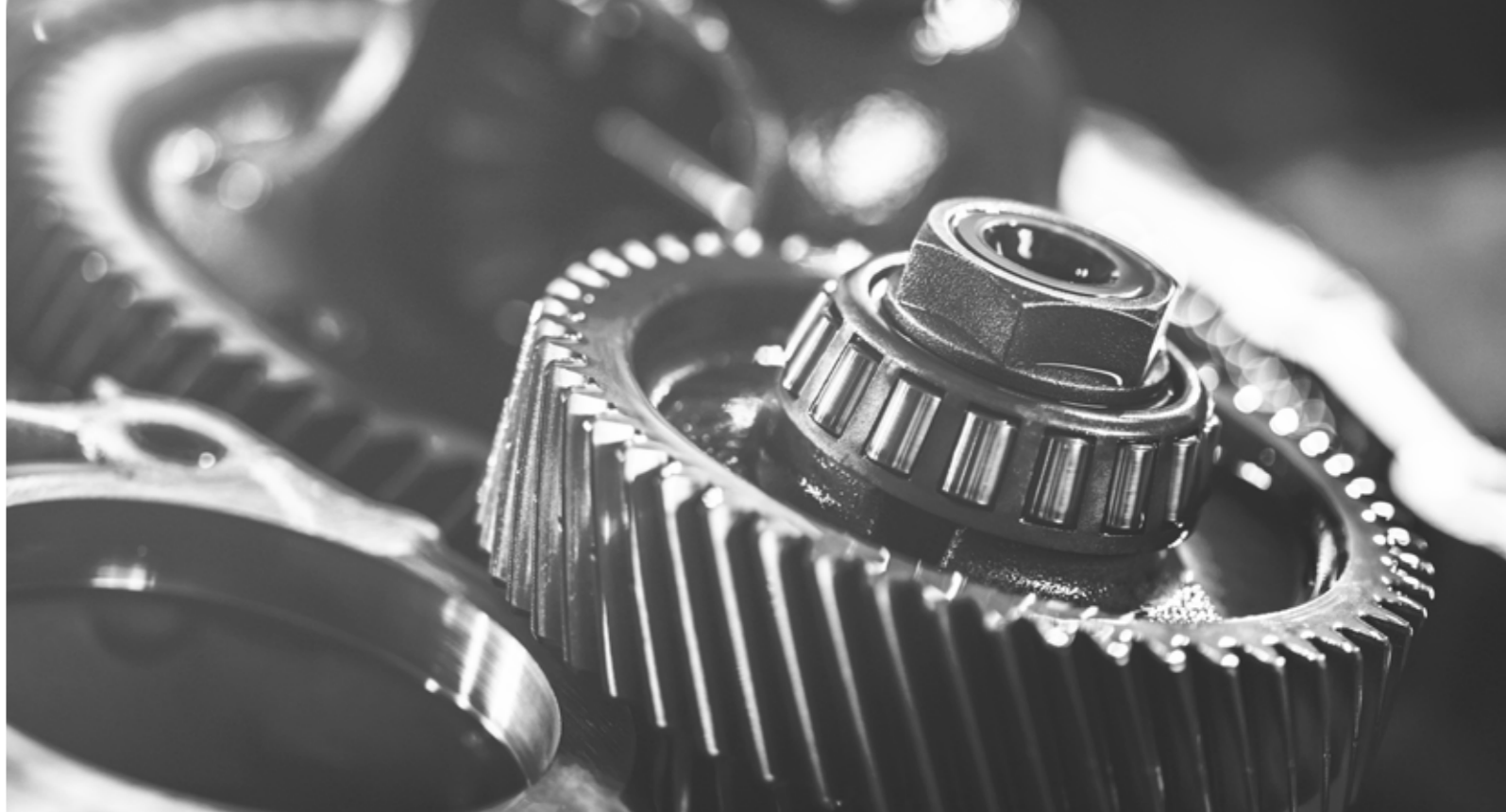

### HARDNESS SCALES



**ROCKWELL** 3kgf – 150kgf



**BRINELL** 1kgf – 250kgf



### ROCKWELL FORCE RANGE:



## HIGHLIGHTS

- 1 Load cell, closed loop, ball bearing linear force actuator.
- 2 Descending test head with collision detection system.
- 3 Built-in laser positioning system and overview camera (optional).
- 4 Extended indenter shaft, with removable high force clamping attachment and indenter protection.
- 5 Integrated high performance system controller, i7 processor, 120GB mSSD storage .
- 6 Industrial 15" touchscreen, option for second screen 15" to 55" or projector.
- 7 IMPRESSIONS™ advanced workflow and tester control software.
- 8 Large test piece accommodation : 345mm (H) X 220mm (D).
- 9 Adjustable power LED workpiece illumination.
- 10 Top-class replaceable body parts, shock proof ABS covers.
- 11 Brinell scales optional

# CREATIVE INNOVATION

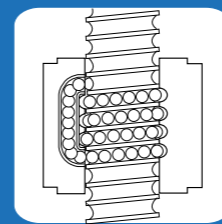

**Z-AXIS BALL SCREW**  
Precision movement

Vertical force actuator with position reading system

Stage and anvil docking station

3-Axis joystick with fine adjustment

## Ultimate precision...

Its lonely on the top for this world class machine. The vertical all linear force actuator of the 6200 eliminates any mechanical tolerance. There are no moving parts between depth reading and the indenter tip. The indenter itself is directly mounted on the load cell. Unbeatable precision. Up to depth reading of 0,02um and a force measurement tolerance of less than 0,05% for the reference version of this Master machine.

**For those that want the best and nothing but the best...  
Comprehensive, multi purpose, clever,  
adaptable, flexible.**

The Graphical User interface (GUI), contains Industry preferred applications, and offers easy to learn, advanced workflow control. A simple test can be set up and conducted in about 3 seconds... IMPRESSIONS™ layout & functions will match not only your particular application requirements, but also meet the needs and preferences of your operators. A user level management system maximizes their comfort and efficiency.

# FEATURED BY IMPRESSIONS v2

## ADVANCED SOFTWARE APPLICATIONS



The unique in the industry, 15" portrait mode, capacitive touchscreen, gives room to all possible applications. Dual screen: For demanding users, a second vertical 15" or 24" landscape screen can be connected. For educational purposes, schools, universities, a full HD projector (beamer) can be connected to the HDMI supported outlet. With this many options in Hardware and Software configuration, yearly updates and on demand upgrades, IMPRESSIONS™ is truly the leading software in the industry.

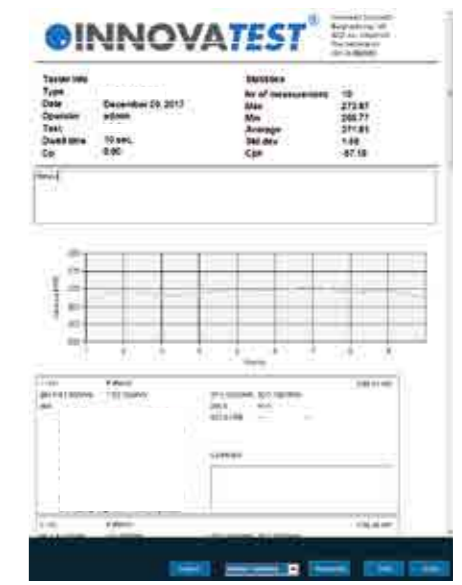

# ABOUT

# IMPRESSIONS™

Easy to operate, time reducing solutions...

## 1 PATTERN TESTING\*

The IMPRESSIONS™ pattern editor allows the user to create any number of test patterns with a large number of variable settings. Create test patterns with great precision and freedom. Verify the settings in the preview mode. Drag & drop patterns from one test sample to another sample. Live vision technique over zoom overview camera, no image stitching required.

Combine different patterns and even different test forces in one program, and run them fully automatically. All test points can be identified individually or to customer specifications. The label is shown in the test result list and in the test results overview and in the results print out. An important function for sample analyses at the end of a test and in the future for review of previous tests.

*\*Includes JOMINY testing patterns*



## 2 USER DEFINED PROGRAMS

For repeating jobs, IMPRESSIONS™ utilizes the option of setting up and storing custom test programs. For each task, a "job" can be created. All application specific parameters, like hardness scale, force, dwell-time, pattern, conversion and the report template are stored in the same program.

## 3 REPORT GENERATOR

Imagine having a report created for you that includes: Your company name, address, contact information, labeled results related to patterns or sequential, pictures of your optical measurements, stitched images, notes section for each result or pictures, rendition of the pattern performed, overview picture of your pattern on your sample, full statistics, summary of your results, go no-go results, Pass or fail...all that information or having the ability to only have what you need reported, we call this our Report Configurator. You decide how much or how little you report by PDF or laser printer. We even keep it simple by choosing export to CSV file, to a thumb drive or network file location. Data management at its best!

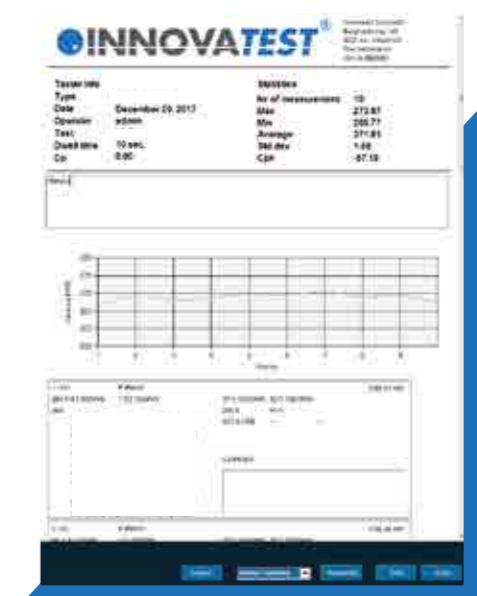

# VARIOUS POSSIBILITIES

The NEMESIS 6200 is a rock-solid Rockwell hardness tester. With a throat depth of 220 mm and a maximum working height of 345 mm, it provides a wide workspace for every type of user. Its solid body work can withstand the hardest environments. Perfectly suitable for aircraft engine parts, automobile parts, production lines, general quality assurance and the highest standard for laboratory use.



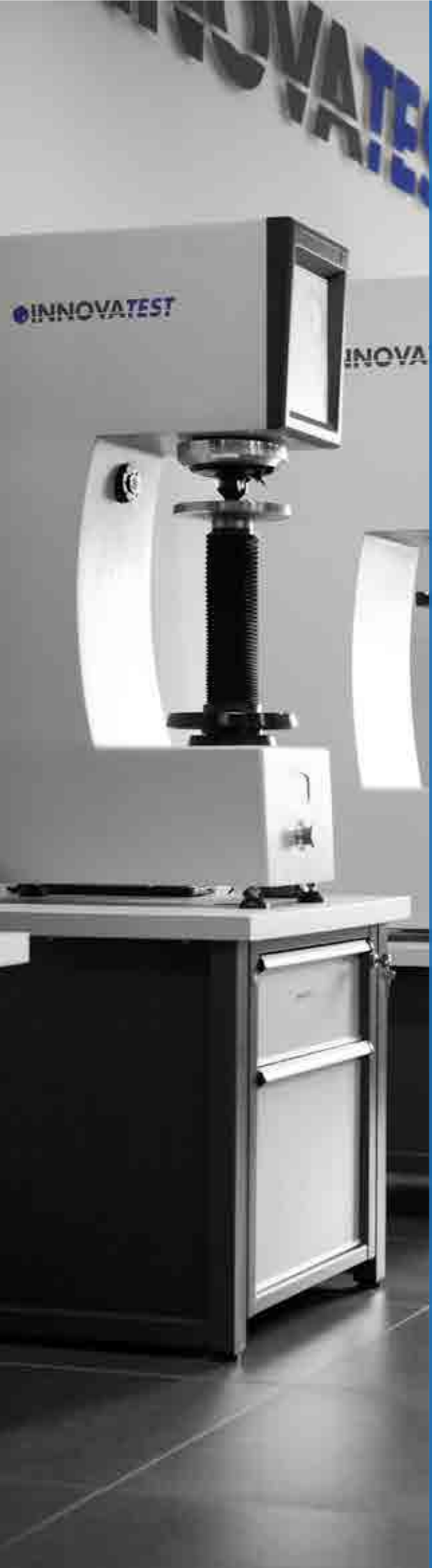

# SUPPORT YOUR BEST TESTING RESULTS

With our rigid designed Bench stands

- Rock solid bench stands
- 100% retractable drawer, bearing guidance, max 100kg load. Rubber anti slip bottom
- Lockable cabinet, 300mm high
- Adjustable feet, (+/- 50mm height adjustable to reach ergonomic working position)
- Made of corrosion resistant zinc plated steel with RAL powder coating
- Carrying capacity of 400kg
- Top surface made of 50mm Plywood with 1.5mm chemical resistant plastic plating, edges made of shock resistant 3mm ABS side liner
- Industrial quality, for workshop or laboratory

Designed for hardness testing instruments, painted in INNOVATEST® RAL colors matching our testers.



UN-STAND/960 71 x 75 x 80 cm



UN-STAND/965 150 x 75 x 80 cm

# ACCESSOIRES NEMESIS 6200

Schematic overview of the configuration options, standard and optional accessories

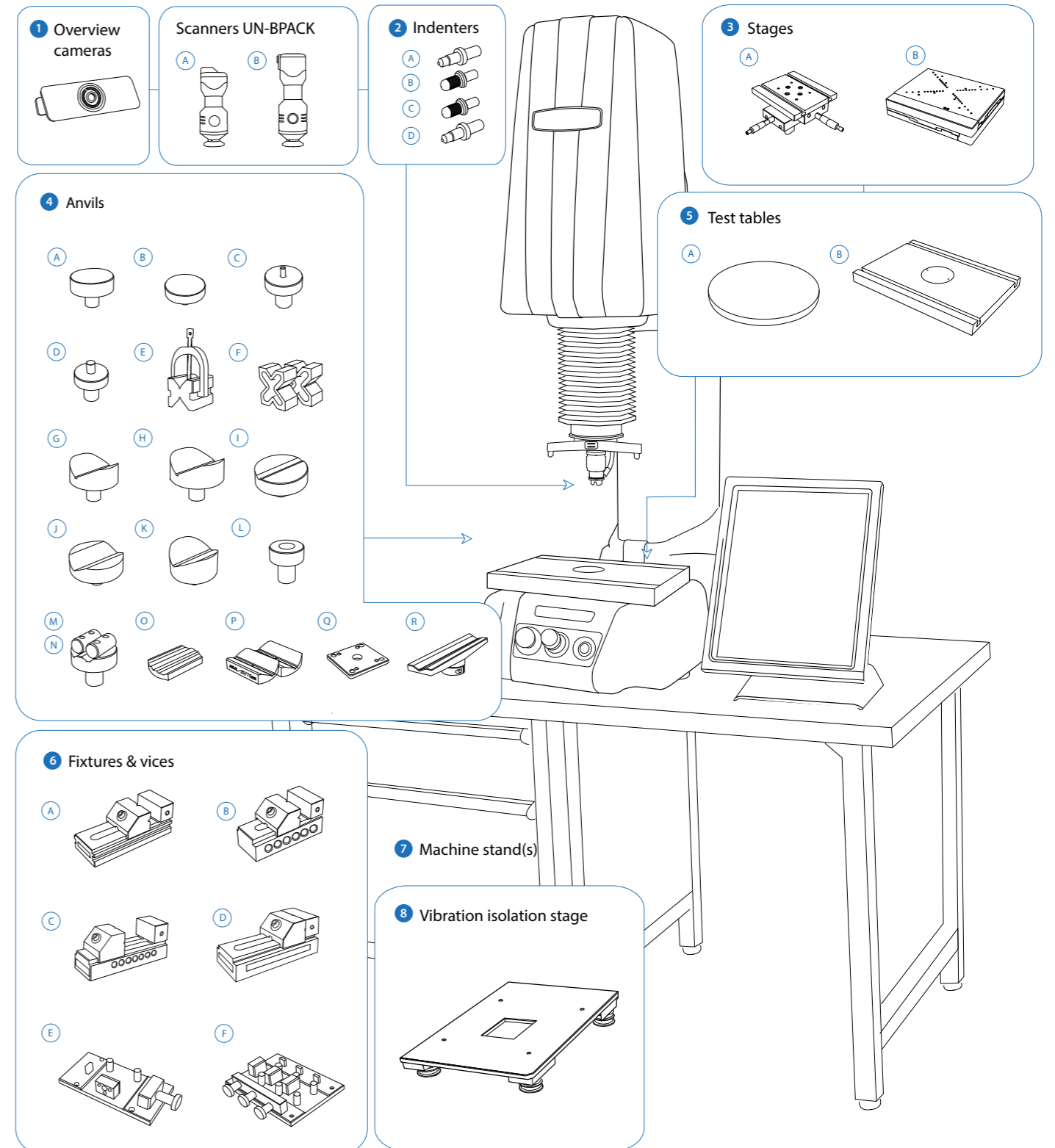

Not all accessories are displayed on this page. Full details can be found on the Order details page.

# ORDER DETAILS

## NEMESIS 6200



NEMESIS 6200 Rockwell hardness tester	NEMESIS 6200RS
Plug & Play prepared, calibration, sea & airworthy packing in "non coniferous wood" material	P&PSEAPACK90

## ACCESSORIES

1	Overview Camera	Overview / Full view zoom camera + software functionality, includes overview lights and laser pointer	SA-05-0002
2	Indenters	A Rockwell C Diamond Indenter, ISO & ASTM certified	IN/6005
		B Brinell Indenter 1mm. Includes 1 carbide ball. Ø6.35mm. ISO & ASTM certified	IN/7000
		Brinell Indenter 2.5mm. Includes 1 carbide ball. Ø6.35mm. ISO & ASTM certified	IN/7005
		Brinell Indenter 5mm. Includes 1 carbide ball. Ø6.35mm. ISO & ASTM certified	IN/7010
		Brinell Indenter 10mm. Includes 1 carbide ball. Ø6.35mm. ISO & ASTM certified	IN/7015
		C Rockwell Ball Indenter 1/16". Includes 1 carbide ball, ISO & ASTM certified	IN/7506
		Rockwell Ball Indenter 1/8". Includes 1 carbide ball, ISO & ASTM certified	IN/7606
		Rockwell Ball Indenter 1/4". Includes 1 carbide ball, ISO & ASTM certified	IN/7706
		Rockwell Ball Indenter 1/2". Includes 1 carbide ball, ISO & ASTM certified	IN/7806
		D Macro Vickers Indenter Ø6.35mm	IN/8010
3	Stages	A Manual X-Y stage with analogue metric micrometers, 180x160mm Displacement: 25x25mm, scale 0.01mm, max load 300kg	UN-TESTTABLE/030
		B Motorized CNC X-Y stage, 257x188mm, total load up to 400Kgf max. Displacement: 120x120mm, resolution 0.001 mm, repeatability +/-0.003mm	UN-XY571212TT
		Motorized CNC X-Y stage, 307x208mm, total load up to 400Kgf max. Displacement: 170x120mm, resolution 0.001mm, repeatability +/-0.003mm	UN-XY571712TT
		Motorized CNC X-Y stage, 357x208mm, total load up to 400Kgf max. Displacement: 220x120mm, resolution 0.001mm, repeatability +/- 0.003mm	UN-XY572212TT
		Motorized CNC X-Y stage, 337x238mm, total load up to 400Kgf max. Displacement: 200x150mm, resolution 0.001mm, repeatability +/- 0.003mm	UN-XY902015
		Motorized CNC X-Y stage, 437x238mm, total load up to 450Kgf max. Displacement: 300x150mm, resolution 0.001mm, repeatability +/- 0.003mm	UN-XY903015
		Motorized CNC X-Y stage, 630x238mm, total load up to 450Kgf max. Displacement: 400x150mm, resolution 0.001mm, repeatability +/-0.003mm	UN-XY904015
		Motorized CNC X-Y stage, 410x280mm, total load up to 4000Kgf max. Displacement: 200x150mm, resolution 0.001mm, repeatability +/- 0.008mm	UN-XY932015
		Motorized CNC X-Y stage, 510x280mm, total load up to 4000Kgf max. Displacement: 300x150mm, resolution 0.001mm, repeatability +/- 0.008mm	UN-XY933015
		Motorized CNC X-Y stage, 630x238mm, total load up to 4000Kgf max. Displacement: 400x150mm, resolution 0.001mm, repeatability better than 0.008mm	UN-XY934015
	Cable sets, mounting & connectivity for motorized stage	Cable set for connecting CNC stage to embedded driver (1 set for 2-axis) 105cm	UN-XY2CABLENBS
4	Anvils	A Flat anvil 60mm	AS3000-19-04
		B Flat anvil 80mm	UN-TESTTABLE/002
		C Spot anvil 5mm	UN-ANVIL/010
		D Spot anvil 10mm	UN-ANVIL/011

		E V block with bracket 40x40x50mm (LxBxH)	UN-VBLOCK404050
		F Steel, cross type, (X) V-block 60x120x100mm 8-90mm pair	UN-CROSSBLOCK01
		G V-anvil ø40mm 6-60mm	UN-ANVIL/005
		H V-anvil ø63mm 10-100mm	UN-ANVIL/006
		I V-Anvil ø80mm 3.3-20mm	UN-ANVIL/040
		J V-Anvil ø80mm 15-80mm	UN-ANVIL/045
		K V-Anvil ø80mm 23-40mm	UN-ANVIL/050
		L Anvil for round specimen dia. 6-25,4mm	UN-ANVIL/200
		M Cylindrical V anvil 6-80mm	UN-CVANVIL680
		N Cylindrical V anvil 50-200mm	UN-CVANVIL50200
		Test table 100x100mm, V groove 20mm wide, 10mm deep	UN-TESTTABLE/040
		O Small V-Anvil 3-20mm requires base plate (Requires Manual/Autom. X-Y stage)	UN-ANVILSV/105
		P Large V-Anvil 20-75mm requires base plate (Requires Manual/Autom. X-Y stage)	UN-ANVILLV/106
		Q Base plate for V-anvils un-anvilsv/105 & 106	UN-VANVILBASEPL
		R Extra long v-anvil (Ø10 - Ø100)	CM-08-0186
5	Test Tables	A Testing table flat ø200mm, screwfix	UN-TESTTABLE/010
		Testing table flat ø235mm, screwfix	UN-TESTTABLE/012
		B Large flat surface testing table 350x250mm, thickness 30mm with 2 T-slots, for large components	UN-TESTTABLE/015
		Large flat surface testing table 450x350mm, thickness 35mm with 2 T-slots, for large components	UN-TESTTABLE/016
		Clamping, Locking & Fixing Adapters	Quick change anvil base (required for mounting testing tables, anvils)
		Dove tail mounting plate	CM-08-0033
		Lock flange	UN-XYZ BUSH50
		Mounting plate for lock flange	UN-XYZ30FP50-55
6	Fixtures and Vices	A Polished precision vice with lock down system, jaw width 25mm, opens 20mm	UN-VICE/210
		B Polished precision vice with lock down system, jaw width 36mm, opens 42mm	UN-VICE/215
		C Polished precision vice with lock down system, jaw width 48mm, opens 75mm	UN-VICE/220
		D Polished precision vice with lock down system, jaw width 75mm, opens 100mm	UN-VICE/230
		E JOMINY Fixture, for 1 quench end test sample, quick release function	UN-JOMFIX1
		F JOMINY Fixture, for 3 quench end test sample, quick release function	UN-JOMFIX3
7	Machine Stands	A Cabinet test table with drawer for hardness testers 71x75x80cm	UN-STAND/960
		B Cabinet test table with drawer for hardness testers 150x75x80cm	UN-STAND/965
		Seaworthy packing box for 950/960	PACK/100
		Seaworthy packing box for 965	PACK/200
8	Vibration Isolation Stage	Passive vibration isolation stage, broad spectrum	UN-AVS-300
		Printer	Printer



Projector	On request, any brand of choice	UN-PROJECTOR	
ISO/ASTM Verification	BRINELL direct and indirect verification/calibration & certification in compliance with ISO & ASTM, NADCAP. Includes direct force and indirect verification report (block readings), GR & R report, flat fee for selected common scales, per scale.	CALCEFRDW/1B	
	ROCKWELL direct and indirect verification/calibration & certification in compliance with ISO & ASTM, NADCAP. Includes direct force and indirect verification report (block readings), GR & R report, flat fee for selected common scales, per scale.	CALCEFRDW/1R	
Cover	Machine cover 800x800x1450mm	UN-COVER7	

# ACCESSORIES

## OVERVIEW CAMERA



SA-05-0002

## SCANNERS

UN-BPACK



SA-12-0001

SA-12-0002

## INDENTERS



## STAGES



UN-TESTTABLE/030



- UN-XY571212TT
- UN-XY571712TT
- UN-XY572212TT
- UN-XY902015
- UN-XY903015
- UN-XY904015
- UN-XY932015
- UN-XY933015
- UN-XY934015

## ANVILS



## TEST TABLES



## FIXTURES AND VICES

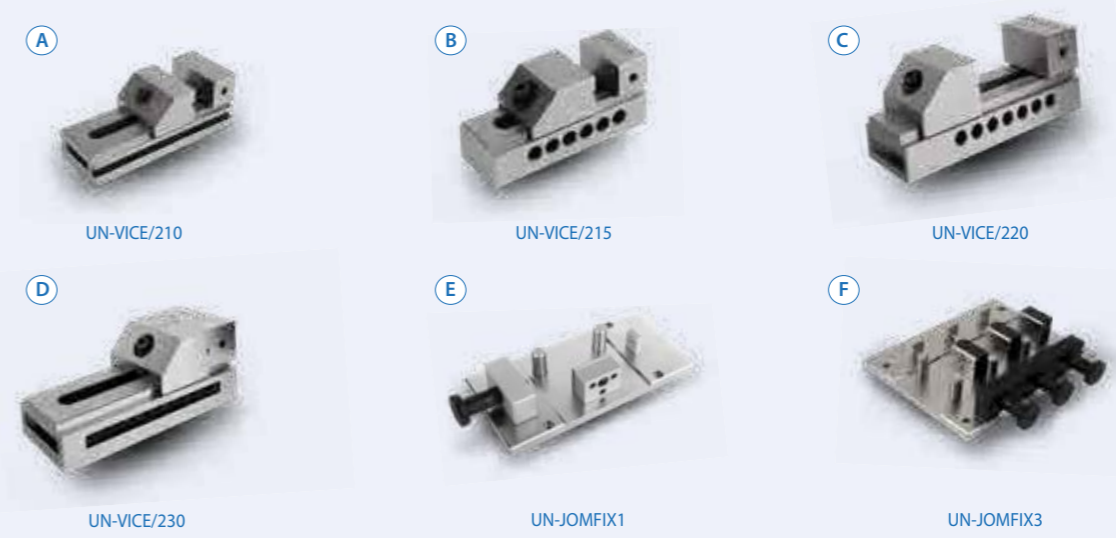

## MACHINE STANDS



## VIBRATION ISOLATION STAGE





# ORDER DETAILS

## SOFTWARE

Additional Software	Automatic measurement	UN-AUTOM	STANDARD	
	Automatic focussing	UN-AUTOFOC	STANDARD	
	Report configurator	UN-REPORTA	STANDARD	
	Snapshot function	UN-SNAPSH	STANDARD	
	Advanced 3 axis coordinate & free style indent pattern configurator, for motorized stage only	UN-TESTPAT01		
	Advanced 3 axis coordinate & free style indent pattern configurator, + CHD, SHD, NHD and edge detection, (supports manual & digital micrometer stages only)	UN-TESTPAT02		
	Force depth/time diagram	UN-FDDIAGR		
	User level management	UN-LEVMAN	STANDARD	
	Manual & automatic on-screen measurement	UN-MANM	STANDARD	
	Q-DAS Certified connectivity protocol	UN-QDAS		
	Advanced 3-axis communication protocol for robotic systems	UN-REMC		
	Virtual Joystick, on screen		STANDARD	
	Connectivity Plus	Powerfull External Intel Core i9 PC, with 16gb RAM, and 512gb SSD drive (or better) Windows 10 pre-installed, IMPRESSIONS™ tester work flow software INNOVATEST recommends Embedded Industrial computers with DeepFreeze enabled.	UN-SYSPCIMP01	
		Powerfull external intel core i9 pc, with 16gb ram, and 512gb ssd drive Windows 10 pre-installed including wiring and integration with tester.	UN-SYSPCIMP02	
Application of customer supplied PC, plus wiring and integration with tester		UN-SYSPCIMP03		
Bluetooth connectivity		UN-BTADAPT		
Utility software; Import test results in MS applications like Excel		UN-SW/905		
USB to USB null modem cable 2.5M		BE-99-0025		
Wireless system Keyboard & wireless mouse		UN-SKBSET		
Upgrades	Upgrade Rockwell tester RS to RSB, Brinell scales, BIOS 1 system, IMPRESSIONS™ V2	UN-BPACK04		
	Upgrade Rockwell tester RS to RSB, Brinell scales, BIOS 2 system, IMPRESSIONS™ V2	UN-BPACK05		

# SPECIFICATIONS

## HARDNESS SCALES

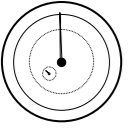
	<b>ROCKWELL</b> EN-ISO 6508 ASTM E18 JIS Z 2245	Regular Rockwell scales; Pre Load 10kgf, Main Load 60kgf   100kgf   150kgf A   B   C   D   E   F   G   H   K   L   M   P   R   S   V Superficial Rockwell scales; Pre Load 3kgf, Main Load 15kgf   30kgf   45kgf 15N   30N   45N   15T   30T   45T   15W   30W   45W   15X   30X   45X   15Y   30Y   45Y
	<b>BRINELL</b> EN-ISO 6506 ASTM E10 JIS Z 2243	HBW1/1   HBW1/1.25   HBW1/2.5   HBW1/5   HBW1/10   HBW1/30 HBW2.5/6.25   HBW2.5/7.8125   HBW2.5/15.625   HBW2.5/31.25   HBW2.5/62.5   HBW2.5/187.5 HBW5/25   HBW5/31.25   HBW5/62.5   HBW5/125   HBW5/250 HBW10/100   HBW10/125   HBW10/250
	<b>HVD (HVT)</b>	HV5   HV10   HV20   HV25   HV30   HV40   HV50   HV60   HV100   HV120   HV125   HV150
	<b>HBD (HBT)</b>	HB1/5   HB1/10   HB1/30 HB2.5/6.25   HB2.5/7.8125   HB2.5/15.625   HB2.5/31.25   HB2.5/62.5   HB2.5/187.5 HB5/25   HB5/31.25   HB5/62.5   HB5/125   HB5/250 HB10/100   HB10/125   HB10/250
	<b>CARBON</b>	HR 2.5/7   HR 5/7   HR 5/15   HR 5/20   HR 5/40   HR 5/60   HR 5/100   HR 5/150   HR 10/20 HR 10/40   HR 10/60   HR 10/100   HR 10/150
	<b>CONVERSIONS</b>	Conversion to other hardness scales according to ASTM E140, ISO 18265, GB/T 1172

## TEST FORCE

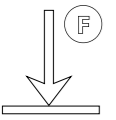
	<b>Force application</b>	Load cell, force feedback, closed loop system, fully automatic
	<b>Test forces</b>	Pre Load : 3kgf & 10kgf. Main Load : 15kgf, 30kgf, 45kgf, 60kgf, 100kgf & 150kgf
	<b>Force range per model</b>	6200RS 3kgf – 150kgf 6200RSB 1kgf – 250kgf
	<b>Test force tolerance</b>	<0.5% <0.05% for LAB model
	<b>Depth reading</b>	<0.1µm <0.05µm for LAB model

## SYSTEM

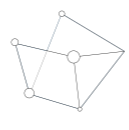
	<b>Electronic system</b>	High performance embedded micro system controller, MS Windows®, 15" full color capacitive touchscreen, automatic and manual measurement.
	<b>CNC Support</b>	5 Axis CNC controller (for motorized stages) or stage accessories
	<b>Screen(s)</b>	15" full colour touchscreen.
	<b>Display resolution</b>	Selectable 0.1 or 0.01HR, 0.5HB, others 0.1
	<b>Statistics</b>	Total test, max, min, average, range, standard deviation, All in real time after each test
	<b>Hardness conversion</b>	Rockwell, Rockwell Superficial, Vickers, Brinell, Knoop, Leeb & Tensile
	<b>Software</b>	IMPRESSIONS™ tester and work flow control. Advanced software features including pattern testing on complex parts and X-Y stage control.
	<b>Data storage capacity</b>	Internal and external mSSD, SSD or HDD
	<b>Data output</b>	XML, CSV, Certified for Q-DAS (Optional)
<b>Connectivity</b>	2 x USB, RJ45 LAN, W-LAN, 5 axis CNC connector, HDMI	
<b>Printer</b>	A4, A3 full color laser printer (optional)	

## GENERAL

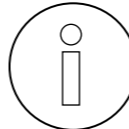
	<b>Machine dimension</b>	1300mm (H) x 448mm (W) x 738mm (D)
	<b>Machine weight</b>	150kg
	<b>Workpiece accommodation</b>	345mm (H) X 220mm (D)
	<b>Power supply</b>	100VAC to 240VAC, 50/60Hz, single phase
	<b>Operating temperature</b>	10°C to 35°C
	<b>Power consumption</b>	100W
	<b>Humidity</b>	10% to 90%, non-condensing
<b>Noise emission</b>	< 70 db(A)	

# TECHNICAL DRAWINGS

All dimensions in these drawings are in mm, approximate. Working heights and or workpiece accommodation varies depending on the stages and stage accessories used.

Please contact our sales department for more details.

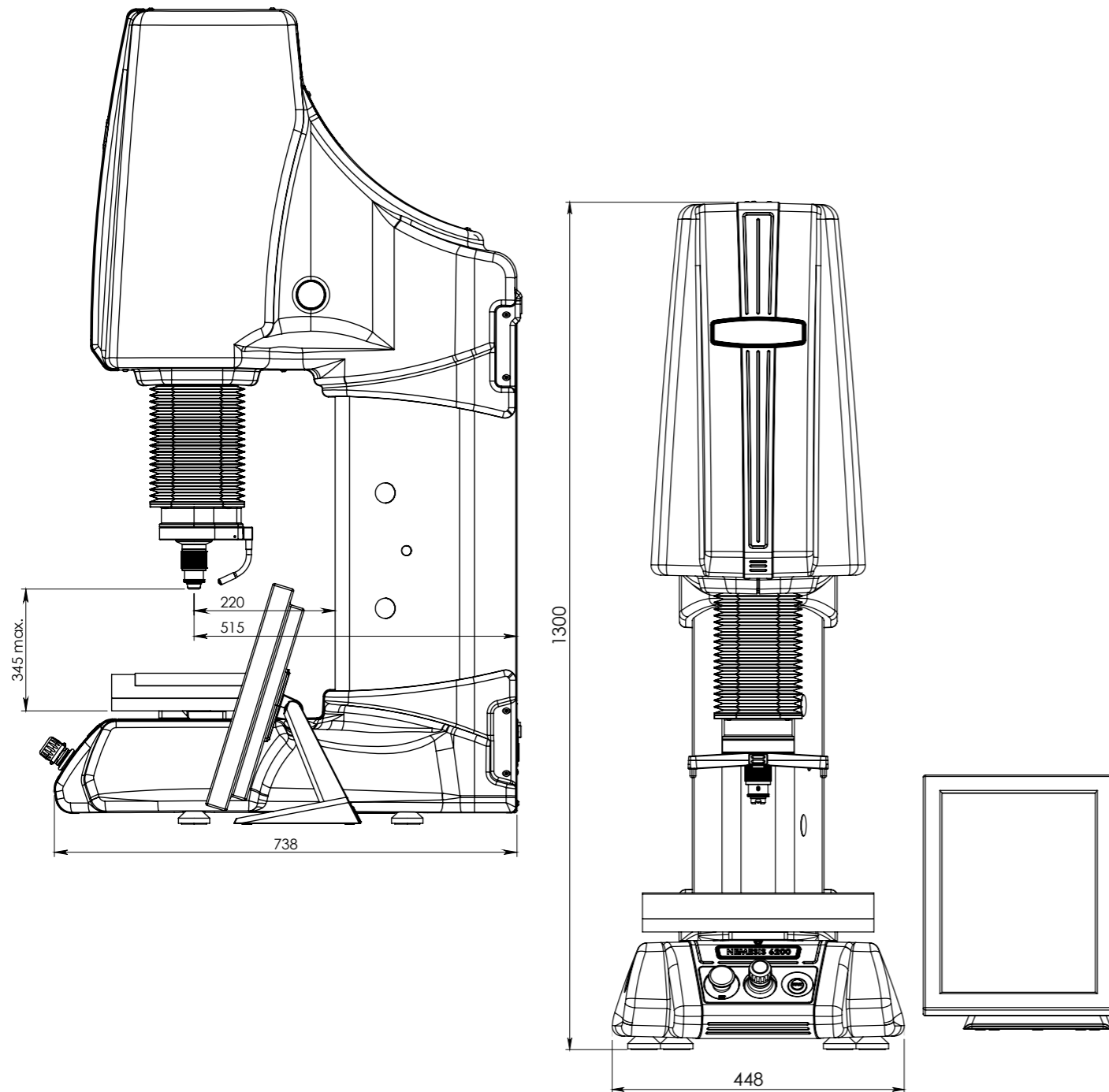

## OTHER MODELS IN THE ROCKWELL RANGE



### FENIX 200AR

Load applied from a dead weight force actuator Rockwell / Brinell hardness tester.

*See brochure B18F200/XX*



### FENIX 300RS

Load Cell, Closed loop, force feedback, test force application system Rockwell / Brinell Hardness tester with I-TOUCH™ system.

*See brochure B20F300/XX*



### VERZUS 720

Load Cell, Closed loop Rockwell/Super Rockwell/ Brinell Hardness tester, with direct depth measuring system, integrated PC, Windows 10, WiFi, full color touchscreen.

*See brochure B19V720/XX*



### HAWK 250RS/400RS

Load Cell, Closed loop Rockwell/Superficial Rockwell hardness tester, with direct depth measuring system, Graphic User Interface, 6.5" Full color touchscreen.

*See brochure B20HSERIES/XX*



### HAWK 652RS-IMP

Load Cell, Closed loop, Fully automatic Rockwell/ Superficial Rockwell hardness tester with dual motorized Z-Axis, IMPRESSIONS™ software, 15" industrial capacitive touchscreen.

*See brochure B20HSERIES/XX*



### NEMESIS 6100

Load Cell, Closed loop  
Fully automatic Rockwell/  
Superficial Rockwell  
(Brinell) Hardness tester  
with descending test head  
& fixed workpiece position.  
full color touchscreen  
operation.  
*See brochure B19N6100/XX*



### NEMESIS 9100RSB

Load Cell, Closed loop  
Rockwell/Superficial Rockwell  
Brinell hardness tester,  
with integrated PC,  
Windows 10, WiFi etc.  
full color touchscreen.  
*See brochure B18N9100/XX*



### NEMESIS 9600RSB

Floor type, Load Cell,  
Closed loop.  
Brinell, Rockwell/Superficial  
Rockwell Hardness tester with  
motorized Z-axis & BIOS Brinell  
Indent Optical Scanner  
*See brochure B19N9600/XX*

Distributor :

## **CORPORATE HEAD OFFICE**

### **INNOVATEST Europe BV**

**Manufacturing, Distribution & Service**

Borgharenweg 140  
6222 AA MAASTRICHT  
The Netherlands

Phone: +31 43 3520060

Fax: +31 43 3631168

[info@innovatest-europe.com](mailto:info@innovatest-europe.com)

[www.innovatest-europe.com](http://www.innovatest-europe.com)

#### **INNOVATEST Deutschland GmbH Sales & Service**

Phone: +49 245 670 59 500  
[info@innovatest-deutschland.com](mailto:info@innovatest-deutschland.com)  
[www.innovatest-deutschland.com](http://www.innovatest-deutschland.com)

#### **INNOVATEST France SARL Sales & Service**

Phone: +33 1848 88038  
[info@innovatest-france.com](mailto:info@innovatest-france.com)  
[www.innovatest-france.com](http://www.innovatest-france.com)

#### **INNOVATEST USA Company Sales & Service**

Phone: +1 267 317 4300  
[info@innovatest-usa.com](mailto:info@innovatest-usa.com)  
[www.innovatest-usa.com](http://www.innovatest-usa.com)

#### **INNOVATEST Japan Co., Ltd. Sales & Service**

Phone: +81 3 3527 3092  
[info@innovatest-japan.com](mailto:info@innovatest-japan.com)  
[www.innovatest-japan.com](http://www.innovatest-japan.com)

#### **INNOVATEST UK Ltd. Sales & Service**

Phone: +44 121 274 0105  
[info@innovatest-uk.com](mailto:info@innovatest-uk.com)  
[www.innovatest-uk.com](http://www.innovatest-uk.com)

#### **INNOVATEST Polska sp. z.o.o Sales & Service**

Phone: +48 697 099 826  
[info@innovatest-polska.pl](mailto:info@innovatest-polska.pl)  
[www.innovatest-polska.pl](http://www.innovatest-polska.pl)

#### **INNOVATEST Shanghai Co., Ltd. Sales & Service**

Phone: +86 21 60906200  
[info@innovatest-shanghai.com](mailto:info@innovatest-shanghai.com)  
[www.innovatest-shanghai.com](http://www.innovatest-shanghai.com)

#### **INNOVATEST South East Asia Sales & Service**

Phone: +65 6451 1123  
[info@innovatest-singapore.com](mailto:info@innovatest-singapore.com)  
[www.innovatest-singapore.com](http://www.innovatest-singapore.com)